



## PLİSE PERDE SİSTEMLERİ

- Plise Perde Aksesuarları
- Plise Perde Profiller
- Plise Perde Makina Grubu



Firmamız, **Process Alüminyum ve PVC Sistemleri** ünvanıyla 2002 yılında Konya'da kurulmuştur.

Firmamızın uzmanlaştığı üretim alanları; sineklik sistemleri, cam balkon sistemleri, plise perde sistemleri, zip perde, cam tavan ve tavan kapatma sistemleridir. Tüm bu sistemleri oluşturan plastik aksesuarlar, alüminyum profiller ve polyester tül ile plise perde kumaşları, kendi tesislerimizde üretilmektedir. Tesisimiz 35.000 m<sup>2</sup> kapalı, 15.000 m<sup>2</sup> açık alanı olmak üzere toplam 50.000 m<sup>2</sup>'dir. Plastik enjeksiyon üretim bölümünde 15 adet enjeksiyon makinesi ile 24 saat çalışma esasıyla günlük ortalama 300.000 adet parça üretebilmektedir. Alüminyum ekstrüzyon bölümümüzde aylık ortalama 850 ton alüminyum profil üretilmektedir. Üretilen alüminyum profiller yine kendi tesisimizde yüzey işlemlerinden (eloksal - elektrostatik boya) geçmekte ve son olarak paketlenip sevk edilmektedir. Türkiye içerisinde 900 civarında atölyede ürünlerimiz işlenmekte ve son tüketiciye ulaştırılmaktadır. Türkiye dışında Balkan ülkelerinin tamamı, Avrupa Kıtasında; Almanya, Hollanda, Danimarka, Kuzey Afrikada; Tunus ve Cezayir, Orta Doğuda; Irak ve İsrail'in yanısıra Ermenistan, Azerbaycan, Arap Emirlikleri, Dubai, Katar, Ürdün gibi ülkelerde bayilikler oluşturulmuştur. Şu anda toplam ürünlerimizin %35'ini ihraç etmekteyiz.

Perde sektöründe son zamanların trend ürünü olan plise perde sistemlerini kendi Ar-Ge merkezimizde geliştirerek sektörün hizmetine sunmuş bulunmaktadır. Mekanik perde atölyeleri tarafından bugüne kadar Türkiye genelinde 150 adet bayilik oluşturulmuş ve bu bayilikler artarak çoğalmaktadır. Plise perdeyi oluşturan tüm parçaları; plastik aksesuarlar, alüminyum çıta ve profiller, katlanmış pileli kumaşlar ürünlerimizi kendi tesislerimizde üretilen bayilerimize ulaştırmaktayız. 167 farklı desen ve renkte kumaş çeşidi olan firmamız çok güçlü stok altyapısı ile sektörün ihtiyacı olan hizmeti ve hızı sunmaktadır.

Our company, operating under the name of **Process Aluminum and PVC Systems**, was founded in 2002 in Konya.

Process specializes in the production of the following areas: insect screen systems, glass balcony systems, pleated blind systems, zip blinds, glass roofs, and ceiling closure systems. All the plastic accessories, aluminum profiles, polyester mesh, and pleated blind fabrics that make up these systems are manufactured in our own facilities. Our facility covers a total area of 50,000 m<sup>2</sup>, with 35,000 m<sup>2</sup> indoors and 15,000 m<sup>2</sup> outdoors. In the plastic injection production department, we can produce an average of 300,000 pieces per day with 15 injection machines operating 24 hours a day. In our aluminum extrusion department, an average of 850 tons of aluminum profiles are produced monthly. The aluminum profiles produced undergo surface treatments (anodizing - electrostatic paint) in our own facilities before being packaged and shipped. Within Turkey, our products are processed in approximately 900 workshops and delivered to end consumers. Outside of Turkey, we have established dealerships in all Balkan countries, across the European continent including Germany, Netherlands, France, and Denmark, in North Africa including Tunisia and Algeria, in the Middle East including Iraq and Israel, as well as in countries such as Georgia, Armenia, Azerbaijan, the United Arab Emirates, Dubai, Qatar, Jordan, and more. Currently, we export 35% of our total products.

In the curtain sector, our company has developed and introduced pleated blind systems, the trend product of recent years, to the market through our own R&D center. Nowadays, we have established 150 dealerships across Turkey in the mechanical curtain workshops, and the number of dealers is increasing. We manufacture all the components that make up pleated blinds, including plastic accessories, aluminum bars, profiles, and folded pleated fabrics, in our own facilities and deliver them to our dealers. With 167 different patterns and colors of fabric, our company provides the service and speed that the market needs with its strong stock level.



### Plise Perde

Perdecilik sektörünün teknolojik gelişmelere paralel olarak sürekli bir ilerleme göstermesinin sonucunda tüm mekanlarda kullanılabilecek yeni nesil perde sistemleri geliştirilerek müşterilerimizin konforunu sağlamayı hedefliyoruz. Klasik perde kumaşlarından farklı olarak güneş ışınlarını filtrelemek, mekanlarda ısı dengesini sağlamak gibi işlevleri olan teknik kumaşlardan yapılan modern perde modellerinin kullanımı giderek daha yaygın hale geliyor. İple kontrol edilenlerin yanında motorlu alternatifleri de olan plise perde modelleri özellikle modern tarzda dekore edilmiş mekanlara çok iyi uyum sağlıyor.

### Özellikleri

Plise perde sistemlerinin katlanır cam balkonlar, geometrik pencereler PVC pencere ve kapılar için çözüm odaklı olduğunu söylesek yanlış olmayız. Aynı zaman da sürekli olarak ulaşılması zor noktalar için de başarılı çözümler geliştirmiştir. Yarı geçirgen yapısı sayesinde aydınlık ortamlar yaratır.

Katlanır cam balkon sistemlerinde, PVC pencere ve kapılarda, Winter Garden(Kış Bahçesi) Sistemlerde, yat, tekne, tavan perdeleri, çatı perdesi, eğimli ve geometrik pencereler vs. uygulamalarda kullanılmaktadır. Motorlu ve kumandalı sistemlerinde çok rahatlıkla uygulandığı modeller arasındadır.

Yıkabilen, silinebilen özelliği ile plise perde sistemleri kolay kullanım sağlar. Aynı zaman da alev almama özelliği ile de sağlıklı ortamlar yaratır.

### Pleat Curtain

In parallel with the technological developments of the curtain-making industry, We aim to improve the comfort of our customers by developing new-generation curtain systems and to provide the best possible service. Unlike classic curtain fabrics, modern curtain models made of technical fabrics have functions such as filtering sunlight and providing heat balance in spaces, becoming more widespread. Especially in areas decorated in a modern style, motorized pleated blinds are a good alternative to rope-controlled pleated blinds.

### Properties

Pleated curtain systems are a beautiful solution for folding glass balconies, geometric windows, PVC windows, and doors. It has also developed successful solutions that can be used for hard-to-reach spots. Thanks to its semi-permeable structure creates bright environments.

Folding glass balcony systems, PVC windows, and doors, Winter Garden (Winter Garden) Systems, yacht, boat, ceiling curtains, roof curtains, curved and geometric windows, etc. applications are being used.

Pleat curtain systems with washable and wipeable features provides easy use. At the same time, with its non-flammable feature creates healthy and safe environments.



### Mekanlarda Sade ve Modern Bir Görünüm

Plise perdelerin görünümü sade ve detaysızdır, bu yüzden hemen her ortama uyum sağlarlar. Biraz modern - biraz klasik veya daha gösterişli bir görünüm istediğiniz mekanlar için plise perdeyi kumaş perdelerle kombinleyerek de kullanabilirsiniz.

### A Simple and Modern Appearance in Spaces

The appearance of pleated curtains is plain and without details, so immediately they adapt to any environment. A little modern - a little classic or more Pleat curtain for places where you want a flashy look. You can also use it in combination with fabric curtains.



### İple Kontrol Etmek Tek Seçenek Değil

Plise perdenizi mekanizmasındaki ip sistemi yardımıyla kontrol edebilir veya motorlu olarak üretilmesini tercih edebilirsiniz.

### Rope Control Is Not The Only Option

You can use your pleated curtain with the help of the rope system or you can choose to have a motorized system.



### Plise Perde Nedir?

Katlanır cam balkon sistemleri ve PVC Kapı, pencereler için sıklıkla tercih edilen, ipli mekanizmasıyla aşağı-yukarı yönlü hareket imkanı sağlayan, mekanda gün ışığının yumuşak bir şekilde dağılımını sağlayan bir perde türüdür. Özellikle çatı katları, gemiler, kış bahçeleri, katlanır cam balkon sistemleri gibi mekanların çok köşeli, eğimli, bazen ulaşılması zor olan pencereleri için kullanılmaya uygundur. Görünümü dekoratif, kullanımını pratiktir. Belli bir boyuta kadar tek parça olarak uygulanabildiği gibi ayrı cam kanatlara uygun ebattaki parçalar halinde monte edilerek uygulanabilmektedir.

Modern bir dizaynı olan bu fonksiyonel perde türü tasarım ilkelerinin bir avantajı olarak mekanlarda enerji sarfiyatının azaltılmasına yardımcı olur. Güçlü ve kullanışlı bir perde türüdür. Katlanmış hali çok az yer kapladığı için görüntü kirliliğine yol açmaz. 3 metre uzunluğundaki bir tepe penceresine uygulanması durumunda, toplandığında kapladığı yer 10 cm civarındadır. Farklı renk seçenekleri mevcuttur. Esnek yapısı sayesinde dar bölgelerde, asimetrik formlu, üçgen veya dairesele pencerelerde, tavanlarda kullanılabilir. Pencere kanatlarıyla tavan arasındaki mesafenin az olması durumunda da uygulanabilir. Mekanları sıcak günlerde fazla ısıtmaktan korur, istenilen ölçüde mahremiyet sağlar. Tavan camları veya cam balkon için perdeye ihtiyacınız varsa plise perde sizin için en iyi seçim olacaktır.

### What is Pleat Curtain?

It is a type of curtain that is frequently preferred in folding glass balcony systems and PVC doors and windows and provides soft light to spaces with its up-down movement with a rope mechanism. It is suitable for use on windows which have very angular, curved, that are difficult to reach especially such as spaces folding glass balcony systems in attics, ships, winter gardens. It has a decorative appearance and is practical to use. It can be applied in one piece up to a certain size or in pieces of suitable size for separate glass wings. It is a functional curtain type with a modern design, consisting of a combination of design principles. It has an advantage that helps reduce energy consumption in spaces.

It is a strong and useful type of curtain. It takes very little space when folded therefore does not cause visual pollution. If a 3-meter long curtain applied to the skylight, when its folded the space occupied around 10 cm. Different color options are available. Thanks to its flexible structure, it can be applied to asymmetric, triangular or circular shape windows at ceilings or narrow areas. It can also be applied if the distance between ceiling with window sashes is small. It protects spaces from overheating on hot days, and provides required privacy. If you need curtains for ceiling glazing or a glass balcony, pleated curtain will be the best choice for you.



**T Profil Kapak (Pimli)**  
Pinned T Profile Cover

Paket İçi Adet Quantity Per Package	1.000	Koli İçi Adet Quantity Per Box	1.000
--	-------	-----------------------------------	-------



**Etekli T Profil Kapak (Pimli)**  
Skirted T Profile Cover (With Pin)

Paket İçi Adet Quantity Per Package	1.000	Koli İçi Adet Quantity Per Box	1.000
--	-------	-----------------------------------	-------



**20'lik T Profil Kapak**  
20 T Profile Cover

Paket İçi Adet Quantity Per Package	500	Koli İçi Adet Quantity Per Box	1.000
--	-----	-----------------------------------	-------



**Small T Profil Kapak**  
Small T Profile Cover

Paket İçi Adet Quantity Per Package	1.000	Koli İçi Adet Quantity Per Box	2.000
--	-------	-----------------------------------	-------



**Etekli 20'lik T Profil Kapak (Pimli)**  
Skirted 20 T Profile Cover (With Pin)

Paket İçi Adet Quantity Per Package	500	Koli İçi Adet Quantity Per Box	1.000
--	-----	-----------------------------------	-------



**Çiftli Orta Profil Kapak**  
Double Middle Profile Cover

Paket İçi Adet Quantity Per Package	500	Koli İçi Adet Quantity Per Box	500
--	-----	-----------------------------------	-----



**Yaylı Yapışkan Profil Kapak**  
Spring Adhesive Profile Cover

Paket İçi Adet Quantity Per Package	500	Koli İçi Adet Quantity Per Box	1.000
--	-----	-----------------------------------	-------



**Yaylı Portray Profil Kapak**  
Spring Portray Profile Cover

Paket İçi Adet Quantity Per Package	1.000	Koli İçi Adet Quantity Per Box	1.000
--	-------	-----------------------------------	-------



**Kilit Takımı (Çıtçıtli)**  
Lock Set (with snap fastener)

Paket İçi Adet Quantity Per Package	1.000	Koli İçi Adet Quantity Per Box	2.000
--	-------	-----------------------------------	-------

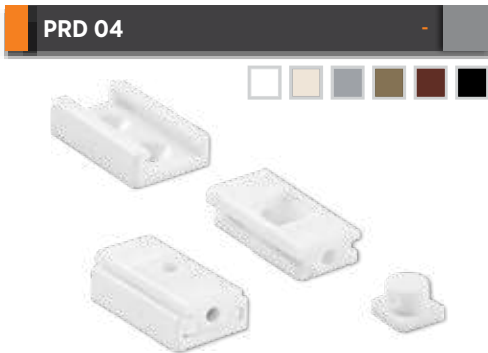

**Kilit Takımı (Alyanlı)**  
Lock Set (with hex key)

Paket İçi Adet Quantity Per Package	1.000	Koli İçi Adet Quantity Per Box	2.000
--	-------	-----------------------------------	-------

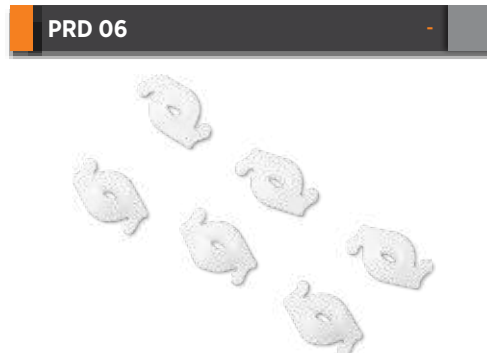

**Çiftli Orta Profil Klips**  
Double Middle Profile Clip

Paket İçi Adet Quantity Per Package	500	Koli İçi Adet Quantity Per Box	1.000
--	-----	-----------------------------------	-------



**Kuş Gözü (Metal) 4 mm**    **Kuş Gözü (Metal) 3 mm**  
Rivet (Metal) 4 mm    Rivet (Metal) 3 mm

Paket İçi Adet Quantity Per Package	5.000	Koli İçi Adet Quantity Per Box	5.000
--	-------	-----------------------------------	-------

PRD 09



**Kuş Gözü (Plastik)**  
Rivet (Plastic)

Paket İçi Adet Quantity Per Package	5.000	Koli İçi Adet Quantity Per Box	10.000
--	-------	-----------------------------------	--------

PRD 47



**Çiftli Orta Profil Klips Anahtarı (Metal)**  
Double Middle Profile Clip Key (Metal)

Paket İçi Adet Quantity Per Package	1	Koli İçi Adet Quantity Per Box	1
--	---	-----------------------------------	---

PRD 35



**Perde Çekme Aparatı**  
Curtain Pulling Apparatus

Paket İçi Adet Quantity Per Package	1	Koli İçi Adet Quantity Per Box	1
--	---	-----------------------------------	---

PRD 34



**Montaj Vidası (2,9x6,5 YHB)**  
Mounting Screw (2.9x6.5 YHB)

Koli İçi Adet Quantity Per Box	10.000
-----------------------------------	--------

PRD 34

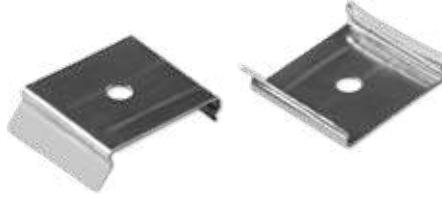

**Portray Profil Metal Klips**  
Portray Profile Metal Clip

Paket İçi Adet Amount within package	500	Koli İçi Adet Amount within parcel	1.000
---	-----	---------------------------------------	-------

PRD 44



**Yaylı Portray Klips**  
Spring Portray Clip

Koli İçi Adet Quantity Per Box	1.000
-----------------------------------	-------

PRD 42



**Yapışkan Profili Yay**  
Adhesive Profile Spring

Paket İçi Adet Amount within package	100	Koli İçi Adet Amount within parcel	500
---	-----	---------------------------------------	-----

PRD 07



**12 mm Bantlı Şerit**  
12 mm Taped Strip

Paket İçi Adet Quantity Per Package	5	Koli İçi Adet Quantity Per Box	500 m
--	---	-----------------------------------	-------

PRD 39



**Çift Taraflı Silikonlu Bant**  
Double Sided Silicone Tape

Paket İçi Adet Quantity Per Package	1	Koli İçi Adet Quantity Per Box	35 m
--	---	-----------------------------------	------

PRD 05



**Plise Perde İp**  
Pleat Curtain Rope

Paket İçi Adet Quantity Per Package	1 rulo/roll	Koli İçi Adet Quantity Per Box	12
--	-------------	-----------------------------------	----

PRD 30

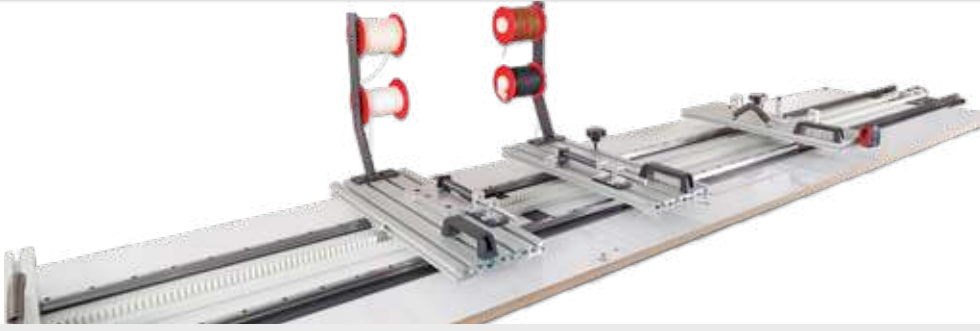

**İp Ayar Boylama Tezgahı**  
Rope Adjustment Lengthening Machine

PRD 31



**Kumaş Delme Makinesi**  
Fabric Punching Machine

PRD 32



**Kumaş Kesim Makinesi**  
Fabric Cutting Machine

PRD 31 A



**Petek Kumaş Delme Makinesi**  
Cellular Fabric Punching Machine



PRD 33



**Perçin Makinesi**  
Rivet Machine



**362**

**T Profil**  
T Profile

Paket İçi Adet Quantity Per Package	10	Gramajı Weight	0,167 kg/m
--	----	-------------------	------------



**357**

**Etekli T Profil**  
Skirted T Profile

Paket İçi Adet Amount within package	10	Gramajı Weight	0,162 kg/m
---	----	-------------------	------------



**334**

**20'lik T Profil**  
20 T Profile

Paket İçi Adet Quantity Per Package	10	Gramajı Weight	0,265 kg/m
--	----	-------------------	------------



**332**

**Small T Profil**  
Small T Profile

Paket İçi Adet Quantity Per Package	10	Gramajı Weight	0,094 kg/m
--	----	-------------------	------------



**945**

**Etekli 20'lik T Profil**  
Skirted 20 T Profile

Paket İçi Adet Amount within package	10	Gramajı Weight	0,193 kg/m
---	----	-------------------	------------



**327**

**Çiftli Orta Profil**  
Double Middle Profile

Paket İçi Adet Quantity Per Package	10	Gramajı Weight	0,252 kg/m
--	----	-------------------	------------



**339**

**Yaylı Yapışkan Profil**  
Spring Adhesive Profile

Paket İçi Adet Quantity Per Package	10	Gramajı Weight	0,102 kg/m
--	----	-------------------	------------



**340**

**Yaylı Portray Profil**  
Spring Portray Profile

Paket İçi Adet Quantity Per Package	10	Gramajı Weight	0,076 kg/m
--	----	-------------------	------------



**330**

**Portray Yapışkan Profil**  
Adhesive Profile

Paket İçi Adet Amount within package	10	Gramajı Weight	0,105 kg/m
---	----	-------------------	------------

### Alüminyum Renk Seçeneği

Aluminum Color Options



9016  
Beyaz  
White



Eloksal Boyalı  
Anodized Painted



Bronz Boyalı  
Bronze Painted

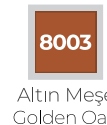

8003  
Altın Meşe  
Golden Oak



8016  
Maun  
Mahogany

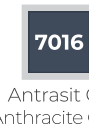

7016  
Antrasit Gri  
Anthracite Gray

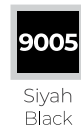

9005  
Siyah  
Black

**362** 0,167 kg/m

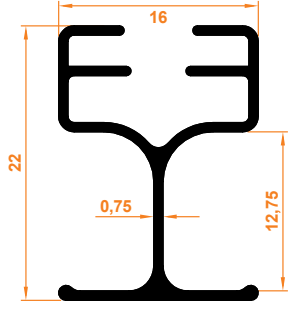

**T Profil**  
T Profile

Paket İçi Adet  
Quantity Per Package

10

**357** 0,162 kg/m

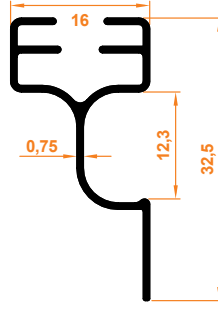

**Etekli T Profil**  
Skirted T Profile

Paket İçi Adet  
Quantity Per Package

10

**334** 0,265 kg/m

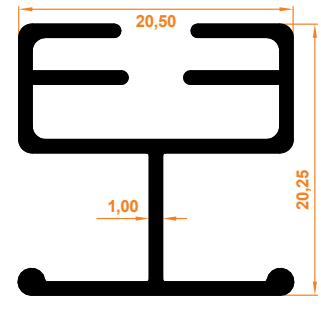

**20'lik T Profil**  
20 T Profile

Paket İçi Adet  
Quantity Per Package

10

**332** 0,094 kg/m

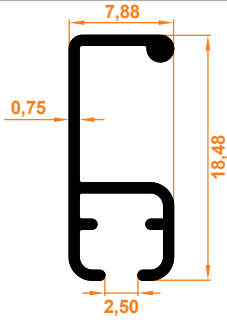

**Small T Profil**  
Small T Profile

Paket İçi Adet  
Quantity Per Package

10

**945** 0,193 kg/m

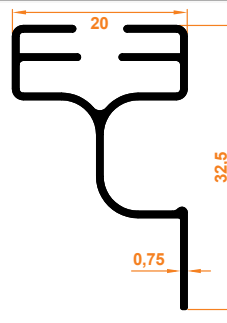

**Etekli 20'lik T Profil**  
Skirted 20 T Profile

Paket İçi Adet  
Quantity Per Package

10

**327** 0,252 kg/m

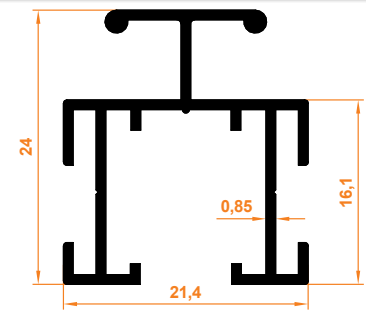

**Çiftli Orta Profil**  
Double Middle Profile

Paket İçi Adet  
Quantity Per Package

10

**339** 0,102 kg/m

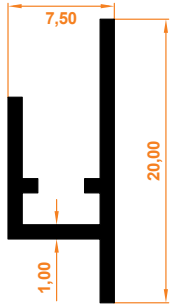

**Yaylı Yapışkan Profil**  
Spring Adhesive Profile

Paket İçi Adet  
Quantity Per Package

10

**340** 0,076 kg/m

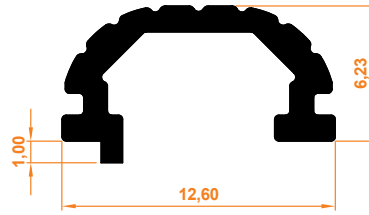

**Yaylı Portray Profil**  
Spring Portray Profile

Paket İçi Adet  
Quantity Per Package

10

**330** 0,105 kg/m



**Portray Yapışkan Profil**  
Adhesive Profile

Paket İçi Adet  
Quantity Per Package

10





Process Alüminyum Plastik San. Tic. Ltd. Şti.

#### MERKEZ

Aşağıpınarbaşı OSB Mah. 524 Nolu Sk. No: 3/1  
42250, Selçuklu-Konya/TÜRKİYE

T : +90 332 248 00 92

F : +90 332 248 00 93

M : info@process.com.tr

#### MARMARA BÖLGE MÜDÜRLÜĞÜ

Cihangir Mh. Talatpaşa Cad. No:67  
Avclar/İSTANBUL - TÜRKİYE

T : +90 212 407 17 42

F : +90 212 407 15 42

M : marmara@process.com.tr

|| [www.process.com.tr](http://www.process.com.tr)

|| [www.demarco.com.tr](http://www.demarco.com.tr)

|| [www.processplise.com.tr](http://www.processplise.com.tr)

|| [www.panjurmen.com.tr](http://www.panjurmen.com.tr)

|| [www.prosin.com.tr](http://www.prosin.com.tr)



[www.process.com.tr](http://www.process.com.tr)