



2025

v.12

**Alüminyum Profil Katalođu**  
Aluminium Profile Catalogue

# ALÜMİNYUM PROFİL GRUBU

Aluminium Profile Group

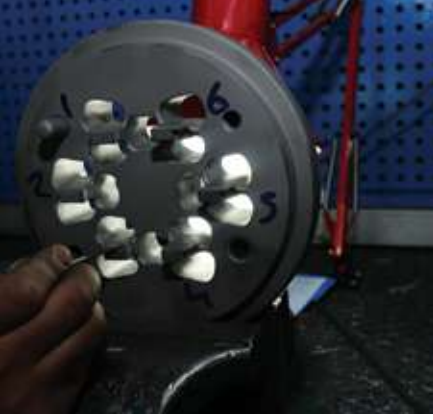

ISO 9001 | ISO 14001 | OHSAS 18001

### GOLD SERİ PLİSE SİNEKLİK / GOLD SERIES PLAİT FLY SCREEN

304

0,318 kg/m

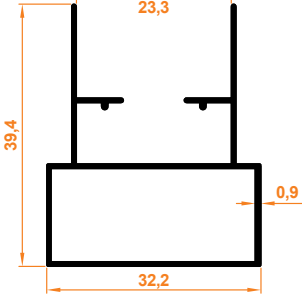

305

0,330 kg/m

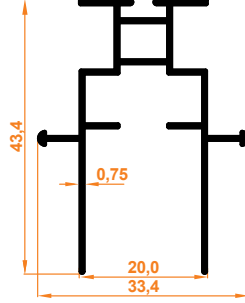

**Gold Kasa Profil**  
Gold Case Profile

Paket İçi Adet  
Quantity Per Package

10

**Gold Kanat Profil**  
Gold Wing Profile

Paket İçi Adet  
Quantity Per Package

10

### STAR SERİ PLİSE SİNEKLİK / STAR SERIES PLAİT FLY SCREEN

302

0,272 kg/m

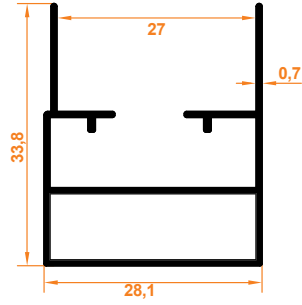

301

0,303 kg/m

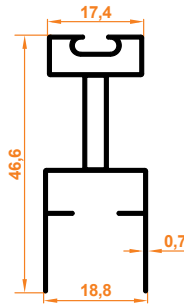

**Star Kasa Profil**  
Star Case Profile

Paket İçi Adet  
Quantity Per Package

10

**Star Kanat Profil**  
Star Wing Profile

Paket İçi Adet  
Quantity Per Package

10

### JUNIOR SERİ PLİSE SİNEKLİK / JUNIOR SERIES PLAİT FLY SCREEN

306

0,243 kg/m

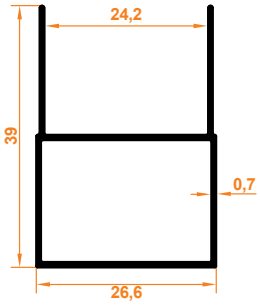

307

0,304 kg/m

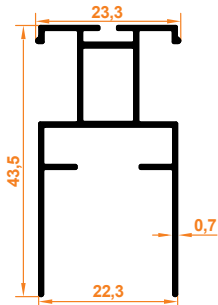

345

0,162 kg/m

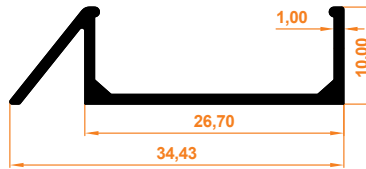

347

0,445 kg/m

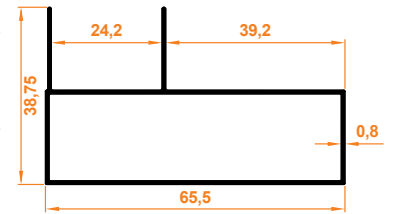

**Junior Kasa Profil**  
Junior Case Profile

Paket İçi Adet  
Quantity Per Package

10

**Junior Kanat Profil**  
Junior Wing Profile

Paket İçi Adet  
Quantity Per Package

10

**Junior Eşiksiz Kasa Profil**  
Junior Case Profile without Threshold

Paket İçi Adet  
Quantity Per Package

12

**Junior Büyük Kasa Profili**  
Junior Big Case Profile

Paket İçi Adet  
Quantity Per Package

8

**SLIM SERİ PLİSE SİNEKLİK / SLIM SERIES PLAİT FLY SCREEN**

**300** 0,218 kg/m

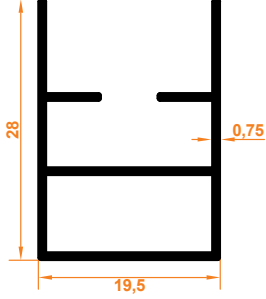

**Slim Kasa Profil**  
Slim Case Profile

Paket İçi Adet  
Quantity Per Package 10

**358** 0,111 kg/m

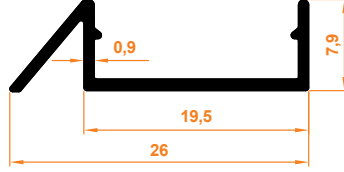

**Slim Eşiksiz Profil**  
Slim Profile without Threshold

Paket İçi Adet  
Quantity Per Package 12

**359** 0,321 kg/m

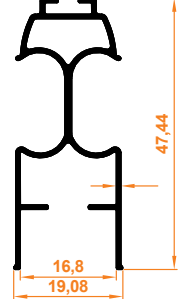

**Slim Kant Profil**  
Slim Wing Profile

Paket İçi Adet  
Quantity Per Package 10

**NOBEL SERİ PLİSE SİNEKLİK / NOBEL SERIES PLAİT FLY SCREEN**

**335** 0,345 kg/m

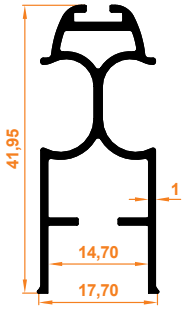

**Nobel Kanat Profili**  
Nobel Wing Profile

Paket İçi Adet  
Quantity Per Package 10

**355** 0,098 kg/m

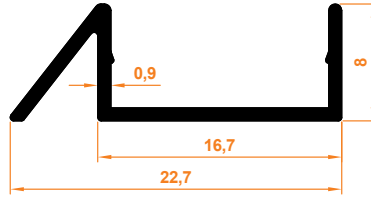

**Nobel Eşiksiz Profili**  
Nobel Profile without Threshold

Paket İçi Adet  
Quantity Per Package 12

**338** 0,250 kg/m

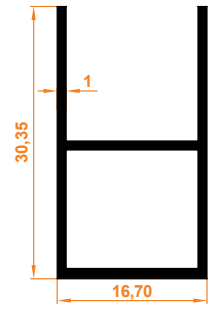

**Nobel Kasa Profili**  
Nobel Case Profile

Paket İçi Adet  
Quantity Per Package 10

**366** 0,277 kg/m

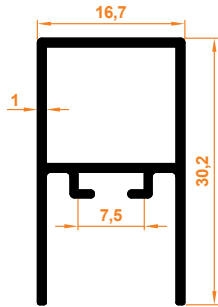

**Nobel Mıknatıs Yuvalı Kasa Profili**  
Nobel Magnet-Channel Frame Profile

Paket İçi Adet  
Quantity Per Package 10

### SÜPER SERİ PLİSE SİNEKLİK / SUPER SERIES PLAIT FLY SCREEN

320

0,303 kg/m

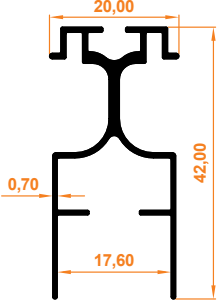

**Süper Seri Kanat Profili**  
Super Wing Profile

Paket İçi Adet | 10  
Quantity Per Package

316

0,248 kg/m

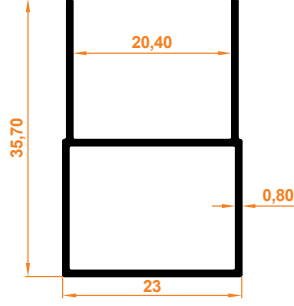

**Süper Seri Kasa Profili**  
Super Case Profile

Paket İçi Adet | 10  
Quantity Per Package

325

0,469 kg/m

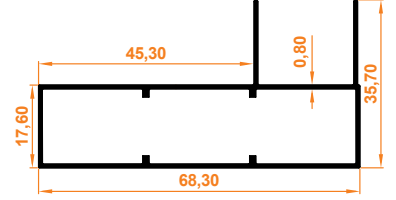

**Süper Büyük Kasa Profili**  
Super Big Case Profile

Paket İçi Adet | 8  
Quantity Per Package

354

0,363 kg/m

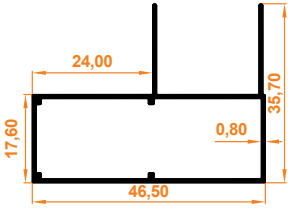

**Süper Orta Kasa Profili**  
Super Middle Case Profile

Paket İçi Adet | 8  
Quantity Per Package

361

0,152 kg/m

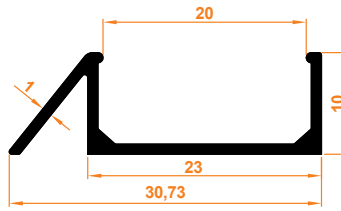

**Süper Eşiksiz Kasa Profil**  
Super without Threshold Case Profile

Paket İçi Adet | 12  
Quantity Per Package

**NOBEL SERİ İÇTEN MONTAJLI PLİSE SİNEKLİK / NOBEL SERIES INTERNAL MOUNTED PLAIT FLY SCREEN**

**363** **0,278 kg/m**

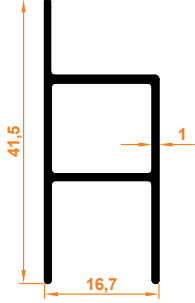

**Nobel İçten/Dıştan Montajlı Kasa Profil**  
Nobel Inside/Outside Mounted Case Profile

Paket İçi Adet  
Quantity Per Package | 10

**335** **0,345 kg/m**

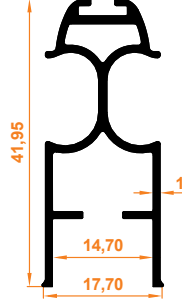

**Nobel Kanat Profili**  
Nobel Wing Profile

Paket İçi Adet  
Quantity Per Package | 10

**SLIM SERİ İÇTEN MONTAJLI PLİSE SİNEKLİK / SLIM SERIES INTERNAL MOUNTED PLAIT FLY SCREEN**

**317** **0,272 kg/m**

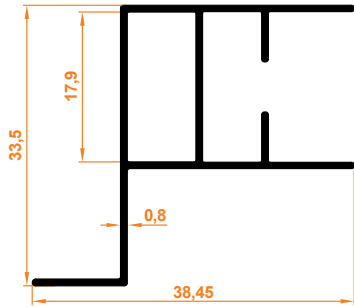

**Kasa Profil**  
Case Profile

Paket İçi Adet  
Quantity Per Package | 10

**359** **0,321 kg/m**

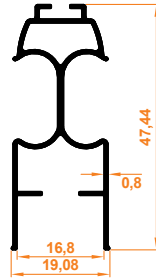

**Slim Kanat Profili**  
Slim Wing Profile

Paket İçi Adet  
Quantity Per Package | 10

**İÇTEN MONTAJLI SABİT SİNEKLİK / INTERNAL MOUNTED FIXED FLY SCREEN**

**405** **0,256 kg/m**

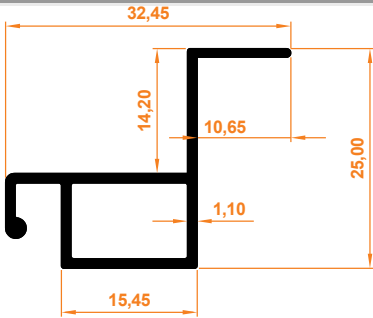

**Kasa Profili**  
Case Profile

Paket İçi Adet  
Quantity Per Package | 10

### AYKİM SERİ SİNEKLİK / AYKİM SERIES FLY SCREEN

309

0,374 kg/m

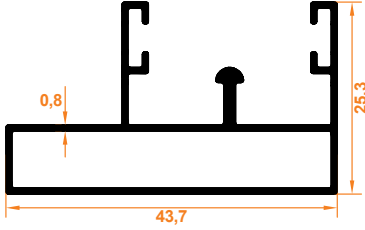

310

0,315 kg/m

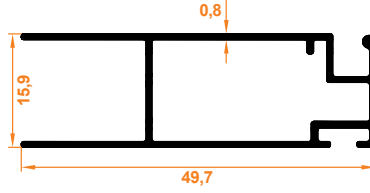

#### Aykim Kasa Profil

Aykim Case Profile

Paket İçi Adet  
Quantity Per Package

8

#### Aykim Hareketli Profil

Aykim Sliding Profile

Paket İçi Adet  
Quantity Per Package

10

### PLATİN SERİ SİNEKLİK / PLATİN SERIES FLY SCREEN

321

0,352 kg/m

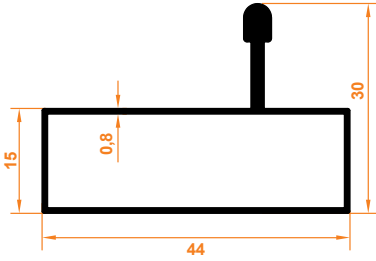

322

0,455 kg/m

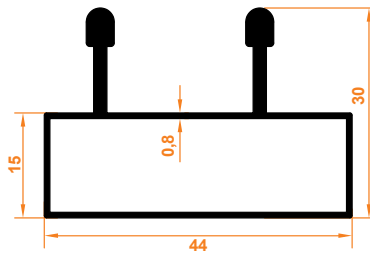

323

0,506 kg/m

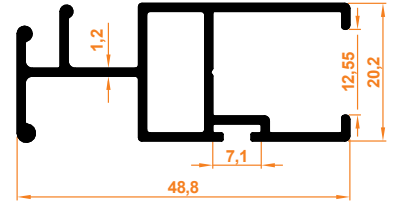

#### Platin Tekli Kasa Profil

Platin Single Case Profile

Paket İçi Adet  
Quantity Per Package

8

#### Platin Çiftli Kasa Profil

Platin Double Case Profile

Paket İçi Adet  
Quantity Per Package

6

#### Platin Kanat Profil

Platin Series Sash Profile

Paket İçi Adet  
Quantity Per Package

10

360

0,306 kg/m

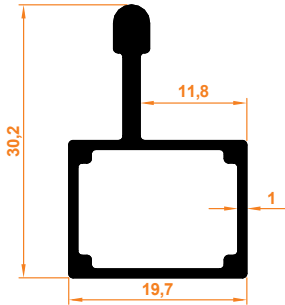

933

0,499 kg/m

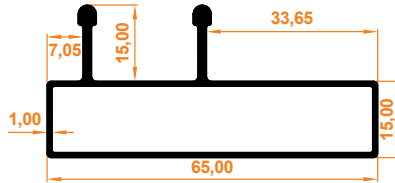

#### Platin Tekli Dar Kasa Profil

Platin Series Single Slim Frame Profile

Paket İçi Adet  
Quantity Per Package

8

#### Platin Geniş Çiftli Kasa Profil

Platin Wide Double Frame Profile

Paket İçi Adet  
Quantity Per Package

6

**DÜZ SİNEKLİK SİSTEMLERİ / FLAT FLY SCREEN PROFILE GROUP**

**400**

**0,105 kg/m**

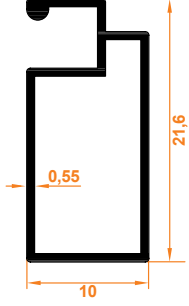

**10x20 Sineklik Profil**  
10x20 Fly Screen Profile

Paket İçi Adet | 20  
Quantity Per Package

**401**

**0,142 kg/m**

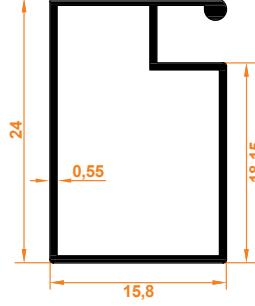

**17x25 Sineklik Profil**  
17x25 Fly Screen Profile

Paket İçi Adet | 20  
Quantity Per Package

**402**

**0,250 kg/m**

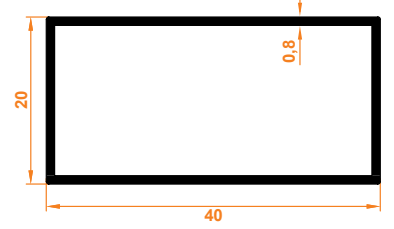

**20x40 Sineklik Profil**  
20x40 Fly Screen Profile

Paket İçi Adet | 10  
Quantity Per Package

**311**

**0,304 kg/m**

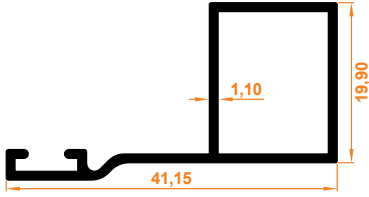

**İçe Açılır Fitilli Sineklik Profil**  
Inward Foldable Flyscreen Profile

Paket İçi Adet | 10  
Quantity Per Package



407

0,342 kg/m

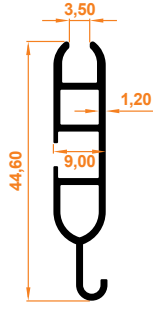

**Stor Kanat Profil**  
Stor Wing Profile

Paket İçi Adet  
Quantity Per Package

6

408

0,286 kg/m

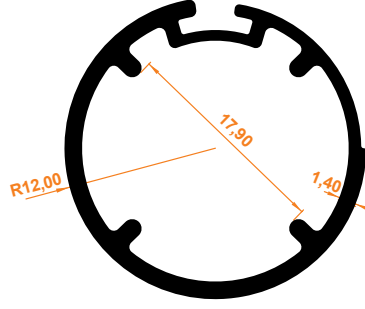

**Stor Boru Profil**  
Stor Pipe Profile

Paket İçi Adet  
Quantity Per Package

6

409

0,526 kg/m

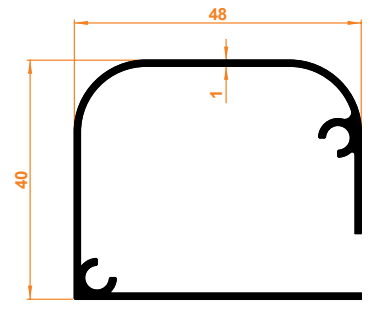

**Stor Kasa Profil**  
Stor Case Profile

Paket İçi Adet  
Quantity Per Package

6

410

0,413 kg/m

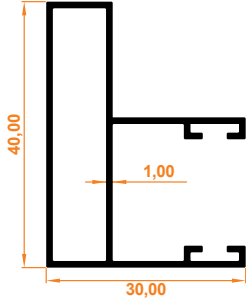

**Stor Yan Kasa Profil**  
Stor Side Case Profile

Paket İçi Adet  
Quantity Per Package

6

411

0,318 kg/m

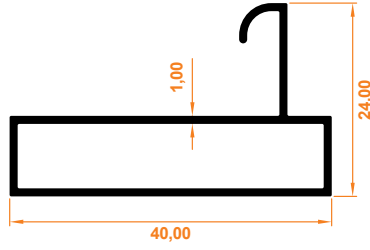

**Stor Alt Kasa Profil**  
Stor Bottom Case Profile

Paket İçi Adet  
Quantity Per Package

6

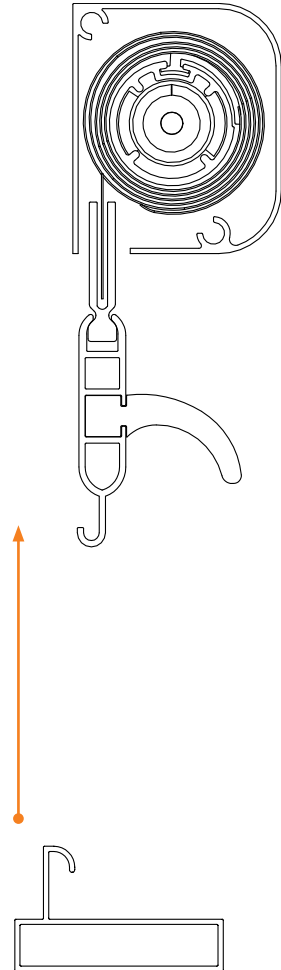
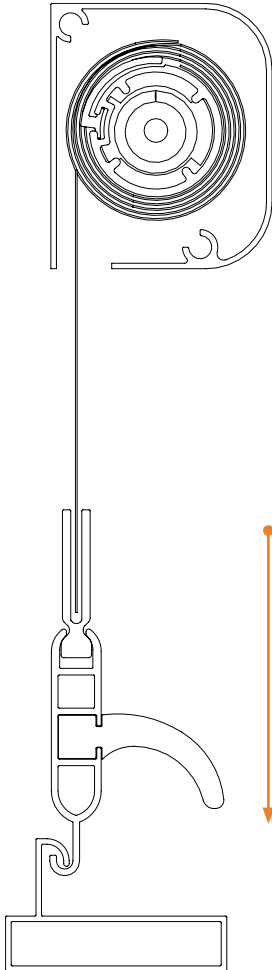

1 0,247 kg/m

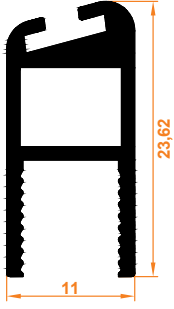

**Büyük D Fitol**  
Big D Wick

Paket İçi Adet  
Quantity Per Package 10

2 0,167 kg/m

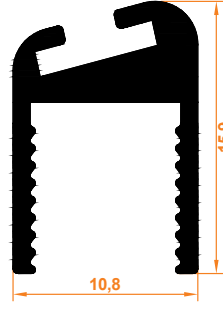

**Küçük D Fitol**  
Small D Wick

Paket İçi Adet  
Quantity Per Package 10

3 0,116 kg/m

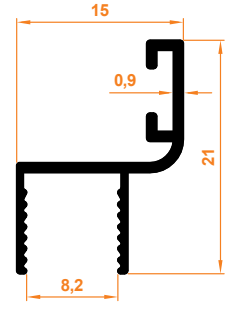

**Küçük h Fitol**  
Small h Wick

Paket İçi Adet  
Quantity Per Package 20

4 0,150 kg/m

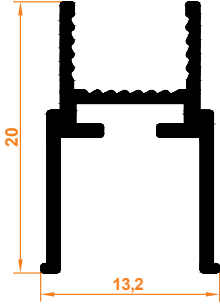

**Orta H Fitol**  
Medium H Wick

Paket İçi Adet  
Quantity Per Package 10

5 0,214 kg/m

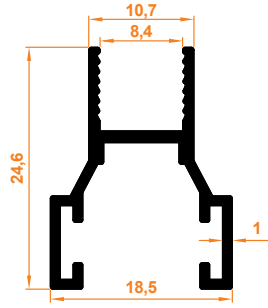

**Büyük H Fitol**  
Big H Wick

Paket İçi Adet  
Quantity Per Package 20

6 0,276 kg/m

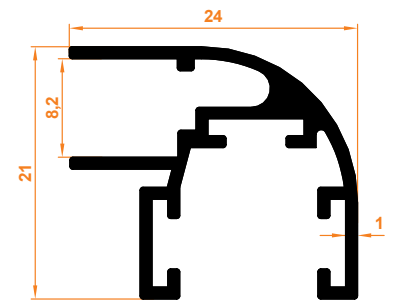

**Köşe Dönüş Fitol**  
Corner Return Wick

Paket İçi Adet  
Quantity Per Package 10

**8 mm CAM BALKON PROFİL GRUBU**  
8 mm Glass Balcony Profile Group

101 0,078 kg/m

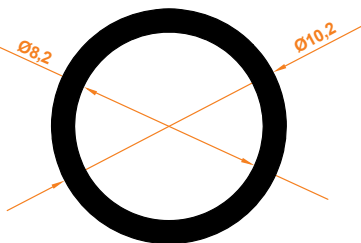

**10'lu Stoplama**  
10 Stopping Profile

Paket İçi Adet  
Quantity Per Package 25

104 0,717 kg/m

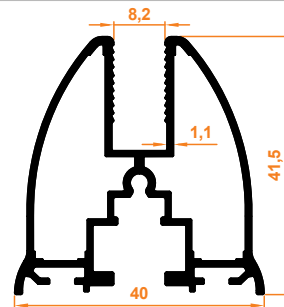

**Gold Baza Profil**  
Gold Base Profile

Paket İçi Adet  
Quantity Per Package 3

105 0,730 kg/m

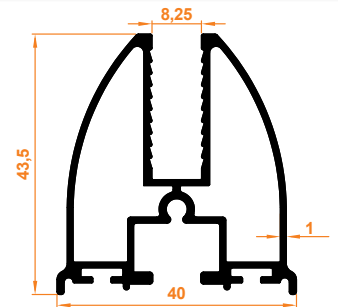

**Firtına Baza Profil**  
Firtına Base Profile

Paket İçi Adet  
Quantity Per Package 3

# 8 mm CAM BALKON PROFİL GRUBU

8 mm Glass Balcony Profile Group

109

1,355 kg/m

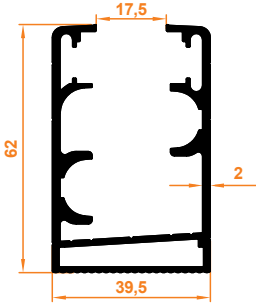

**Düz Kasa Profil**  
Flat Case Profile

Paket İçi Adet  
Quantity Per Package

3

110

1,396 kg/m

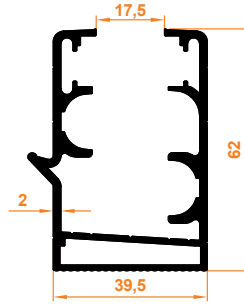

**Oluklu Kasa Profil**  
Corrugated Case Profile

Paket İçi Adet  
Quantity Per Package

3

100

0,441 kg/m

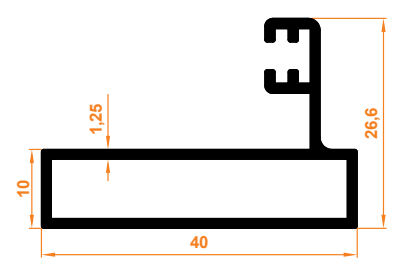

**Dar Yan Dikme**  
Thin Side Column

Paket İçi Adet  
Quantity Per Package

6

106

1,611 kg/m

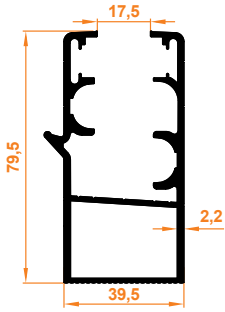

**Oluklu Büyük Kasa Profil**  
Corrugated Big Case Profile

Paket İçi Adet  
Quantity Per Package

3

107

1,570 kg/m

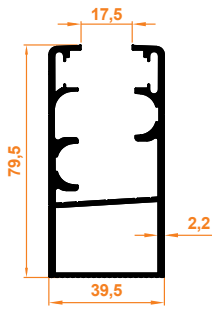

**Büyük Düz Kasa Profil**  
Big Flat Case Profile

Paket İçi Adet  
Quantity Per Package

3

108

0,457 kg/m

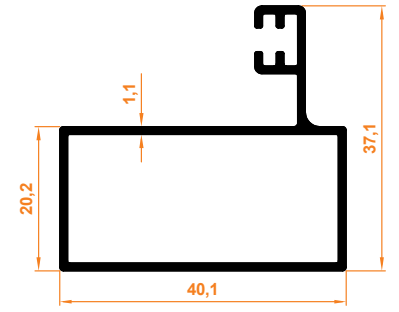

**Geniş Yan Dikme**  
Thick Side Column Profile

Paket İçi Adet  
Quantity Per Package

6

111

1,062 kg/m

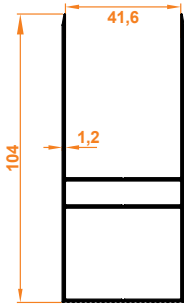

**Stor Profil**  
Stor Profile

Paket İçi Adet  
Quantity Per Package

3

135

0,517 kg/m

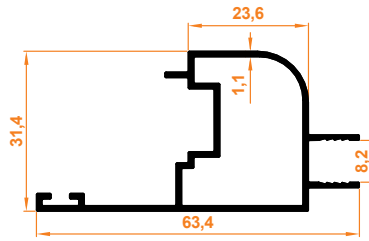

**8 mm İspanyolet Profil**  
8 mm Espagnolette Profile

Paket İçi Adet  
Quantity Per Package

4

136

0,343 kg/m

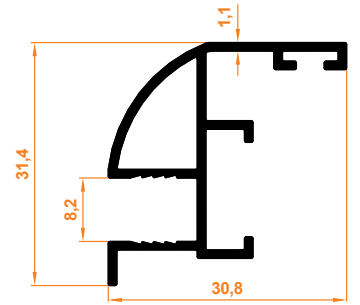

**8 mm İspanyolet Profil Karşılığı**  
8 mm Espagnolette Combination Profile

Paket İçi Adet  
Quantity Per Package

8

932

0,380 kg/m

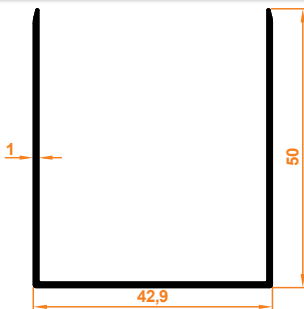

**U Kapatma Profil**  
U Closing Profile

Paket İçi Adet  
Quantity Per Package

10

**800** 0,618 kg/m

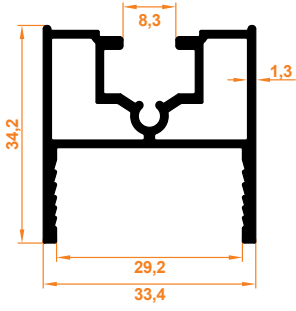

**Baza Profil**  
Base Profile

Paket İçi Adet | 6  
Quantity Per Package

**801** 0,321 kg/m

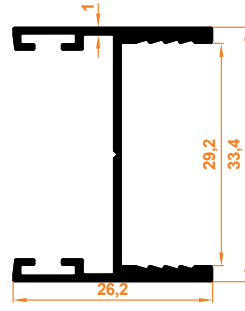

**Düz Kapak Profil**  
Flat Cover Profile

Paket İçi Adet | 6  
Quantity Per Package

**802** 0,327 kg/m

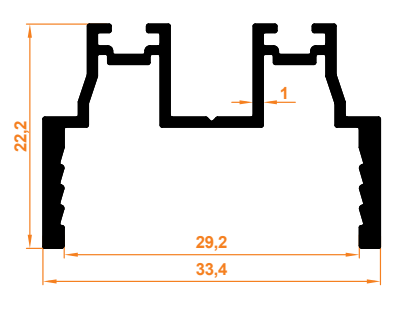

**Düz Kapak Mentеше Profil**  
Flat Cover with Hinge Profile

Paket İçi Adet | 6  
Quantity Per Package

**803** 0,445 kg/m

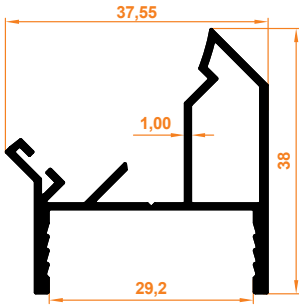

**45° Dönüş Profil**  
45° Return Profile

Paket İçi Adet | 6  
Quantity Per Package

**804** 0,378 kg/m

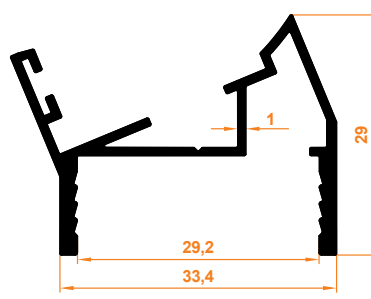

**22,5° Dönüş Profil**  
22,5° Return Profile

Paket İçi Adet | 6  
Quantity Per Package

**805** 0,366 kg/m

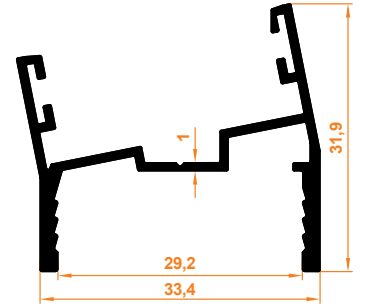

**11° Dönüş Profil**  
11° Return Profile

Paket İçi Adet | 6  
Quantity Per Package

**806** 0,475 kg/m

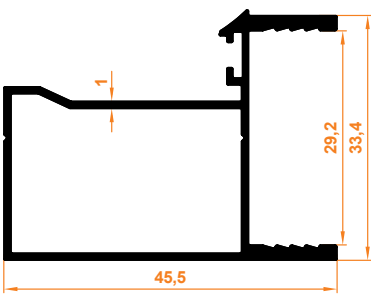

**90° Dönüş Profil**  
90° Return Profile

Paket İçi Adet | 6  
Quantity Per Package

**807** 0,346 kg/m

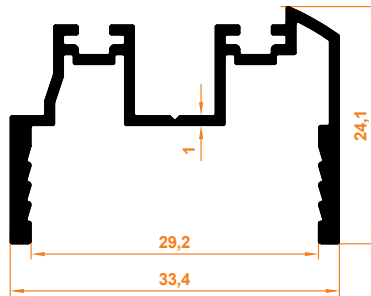

**Açılı Dönüş Mentеше Profil**  
PopUp Return Hinge Profile

Paket İçi Adet | 6  
Quantity Per Package

**808** 0,369 kg/m

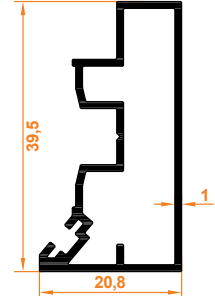

**Yan Dikme Profil**  
Side Column Profile

Paket İçi Adet | 6  
Quantity Per Package

**809** 0,328 kg/m

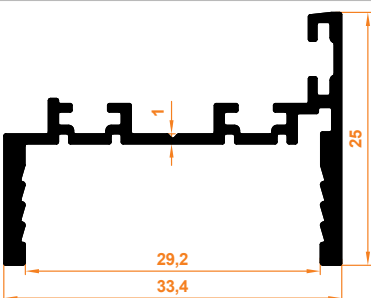

**Sabit Cam Mentеше Profil**  
Stable Glass Hinge Profile

Paket İçi Adet | 6  
Quantity Per Package

**810** 0,355 kg/m

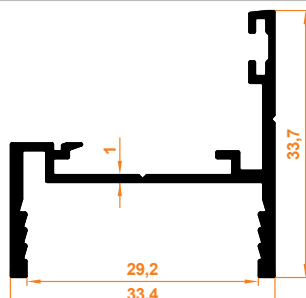

**Sabit Cam Kilit Profil**  
Stable Glass Lock Profile

Paket İçi Adet | 6  
Quantity Per Package

**811** 0,342 kg/m

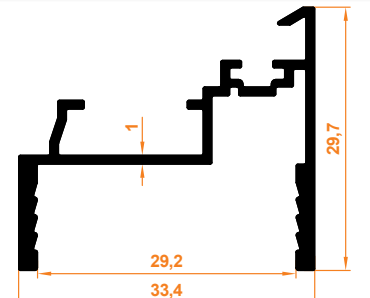

**Sabit Cam Kilit Karşılığı Profil**  
Stable Glass Lock Prevention Profile

Paket İçi Adet | 6  
Quantity Per Package

819

1,344 kg/m

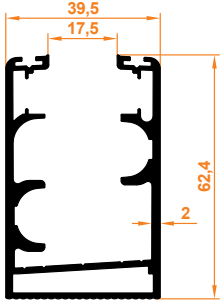

**Düz Kasa Üstten Fitilli Profil**  
Flat Case Top Wicked Profile

Paket İçi Adet | 3  
Quantity Per Package

820

1,389 kg/m

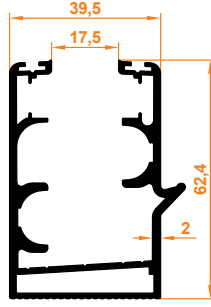

**Oluklu Kasa Üstten Fitilli Profil**  
Corrugated Case Top Wicked Profile

Paket İçi Adet | 3  
Quantity Per Package

822

0,378 kg/m

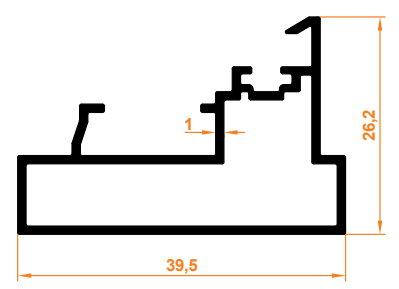

**Açılır Dikme Profil**  
PopUp Column Profile

Paket İçi Adet | 6  
Quantity Per Package

816

1,577 kg/m

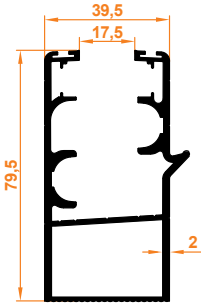

**Üstten Fitilli Büyük Oluklu Kasa**  
Large Corrugated Case with Top Wick

Paket İçi Adet | 3  
Quantity Per Package

817

1,532 kg/m

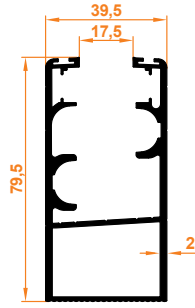

**Üstten Fitilli Büyük Düz Kasa**  
Large Flat Case with Wed from Top

Paket İçi Adet | 3  
Quantity Per Package

815

0,100 kg/m

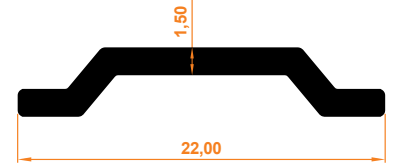

**Tij Profil**  
Espagnolette Profile

Paket İçi Adet | 20  
Quantity Per Package

823

0,459 kg/m

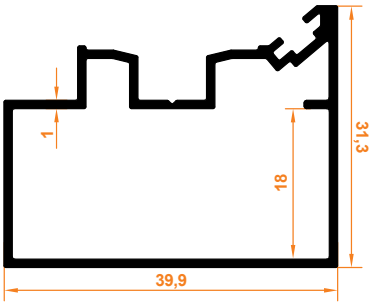

**Geniş Yan Dikme**  
Wide Side Column

Paket İçi Adet | 6  
Quantity Per Package

824

0,583 kg/m

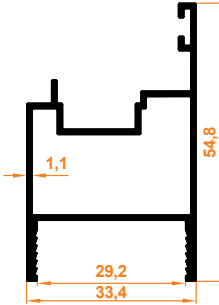

**Sabit Cam İspanyolet Profil**  
Fixed Glass Espagnolette Profile

Paket İçi Adet | 6  
Quantity Per Package

825

0,356 kg/m

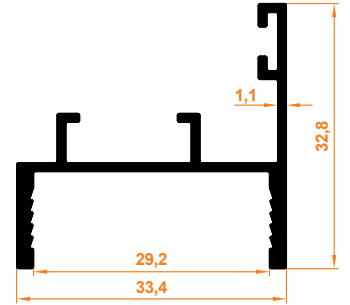

**Sabit Cam İspanyolet Karşılık Profil**  
Fixed Glass Espagnolette Handle Provision Profile

Paket İçi Adet | 6  
Quantity Per Package

932

0,380 kg/m

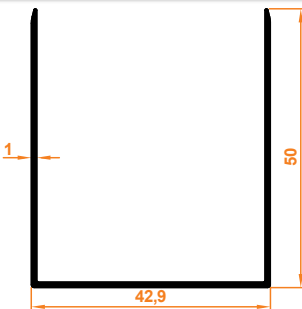

**U Kapatma Profil**  
U Closing Profile

Paket İçi Adet | 10  
Quantity Per Package

111

1,062 kg/m

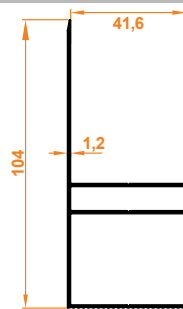

**Stor Profil**  
Stor Profile

Paket İçi Adet | 3  
Quantity Per Package

830

0,680 kg/m

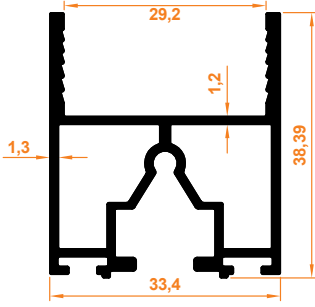

**Fitilli Baza Profili**  
Wicked Base Profile

Paket İçi Adet  
Quantity Per Package

6

801

0,321 kg/m

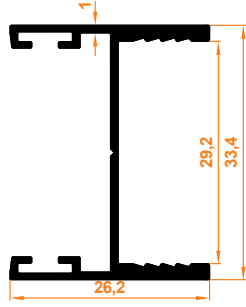

**Düz Kapak Profili**  
Flat Cover Profile

Paket İçi Adet  
Quantity Per Package

6

802

0,327 kg/m

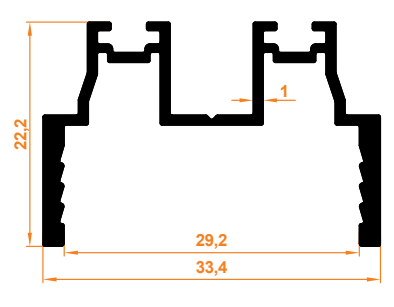

**Düz Kapak Mantel Profili**  
Flat Cover with Hinge Profile

Paket İçi Adet  
Quantity Per Package

6

806

0,475 kg/m

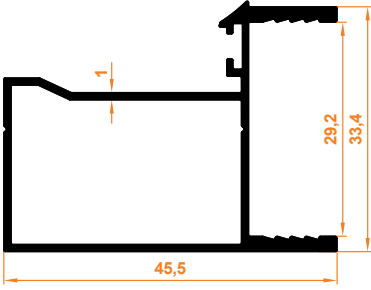

**90° Dönüş Profili**  
90° Return Profile

Paket İçi Adet  
Quantity Per Package

6

807

0,346 kg/m

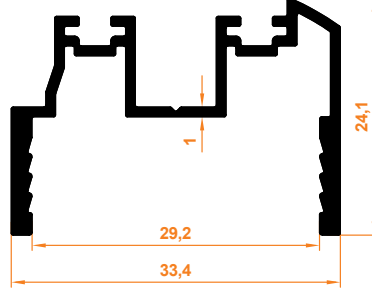

**Açılı Dönüş Mantel Profili**  
PopUp Return Hinge Profile

Paket İçi Adet  
Quantity Per Package

6

808

0,369 kg/m

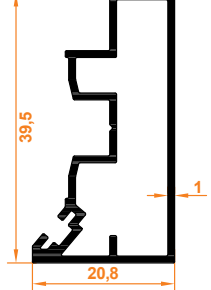

**Yan Dikme Profili**  
Side Column Profile

Paket İçi Adet  
Quantity Per Package

6

809

0,328 kg/m

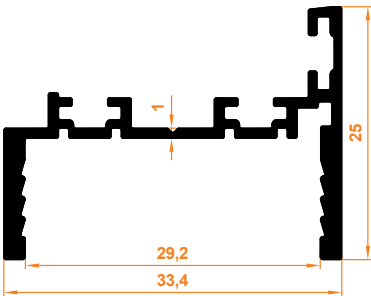

**Sabit Cam Mantel Profili**  
Stable Glass Hinge Profile

Paket İçi Adet  
Quantity Per Package

6

109

1,355 kg/m

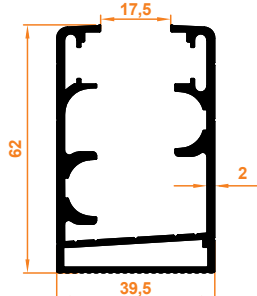

**Düz Kasa Profili**  
Flat Case Profile

Paket İçi Adet  
Quantity Per Package

3

110

1,396 kg/m

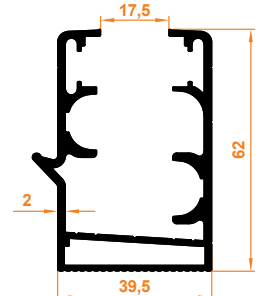

**Oluklu Kasa Profili**  
Corrugated Case Profile

Paket İçi Adet  
Quantity Per Package

3

822

0,378 kg/m

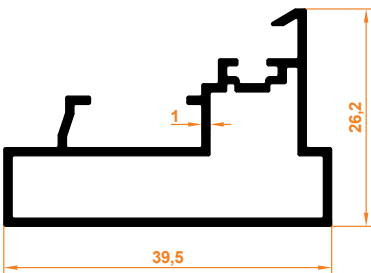

**Açılır Dikme Profili**  
PopUp Column Profile

Paket İçi Adet  
Quantity Per Package

6

106

1,611 kg/m

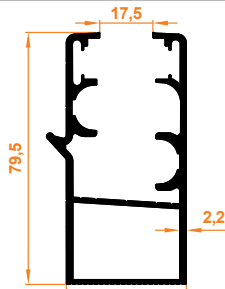

**Oluklu Büyük Kasa Profili**  
Corrugated Big Case Profile

Paket İçi Adet  
Quantity Per Package

3

107

1,570 kg/m

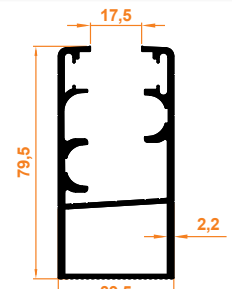

**Büyük Düz Kasa Profili**  
Big Flat Case Profile

Paket İçi Adet  
Quantity Per Package

3

823

0,459 kg/m

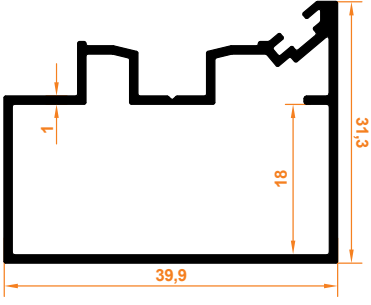

**Geniş Yan Dikme**  
Wide Side Column

Paket İçi Adet  
Quantity Per Package

6

824

0,583 kg/m

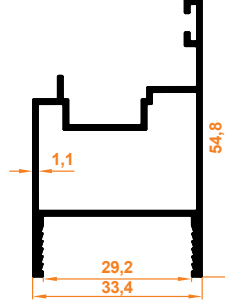

**Sabit Cam İspanyolet Profil**  
Fixed Glass Espagnolette Profile

Paket İçi Adet  
Quantity Per Package

6

825

0,356 kg/m

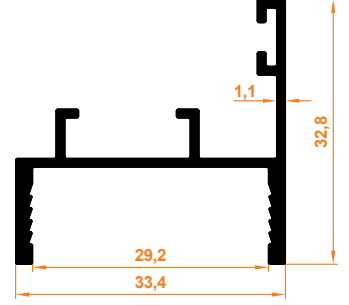

**Sabit Cam İspanyolet Karşılık Profil**  
Fixed Glass Espagnolette Handle Provision Profile

Paket İçi Adet  
Quantity Per Package

6

932

0,380 kg/m

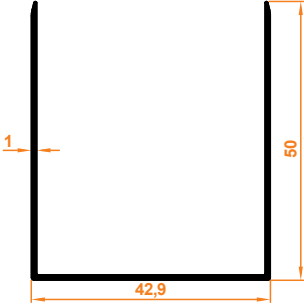

**U Kapatma Profil**  
U Closing Profile

Paket İçi Adet  
Quantity Per Package

10

111

1,062 kg/m

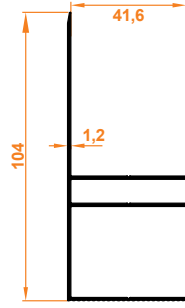

**Stor Profil**  
Stor Profile

Paket İçi Adet  
Quantity Per Package

3

**210** 0,643 kg/m

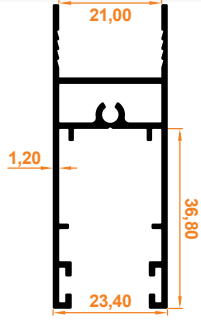

**Sürme Baza Profil**  
Sliding Base Profile

Paket İçi Adet  
Quantity Per Package

5

**215** 0,908 kg/m

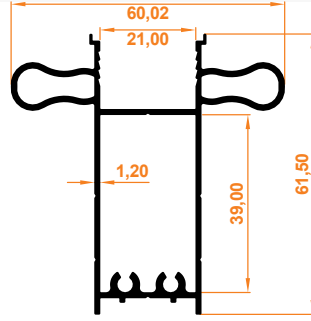

**Çekme Kol Profil**  
Pull Handle Profile

Paket İçi Adet  
Quantity Per Package

3

**212** 0,423 kg/m

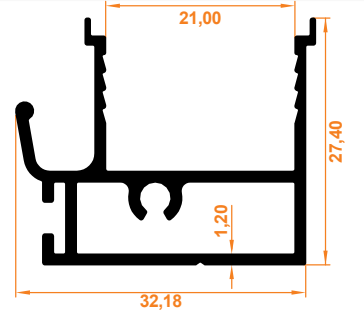

**Kenet Profil**  
Clamp Profile

Paket İçi Adet  
Quantity Per Package

6

**211** 0,301 kg/m

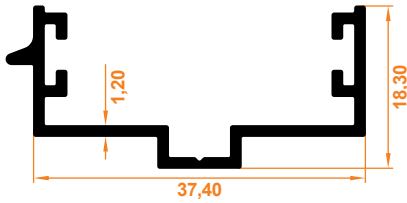

**Birleştirme Karşılık Profil**  
Combination Provisions Profile

Paket İçi Adet  
Quantity Per Package

6

**213** 0,974 kg/m

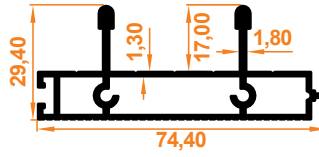

**İkili Eşikli Alt Kasa Profil**  
Double Threshold Lower Case Profile

Paket İçi Adet  
Quantity Per Package

4

**222** 1,333 kg/m

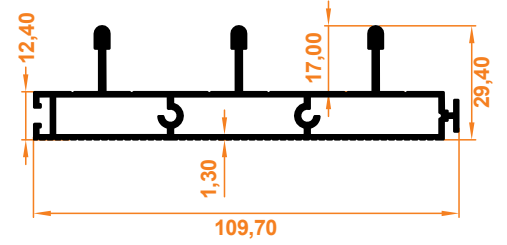

**Üçlü Eşikli Alt Kasa Profil**  
Triple Threshold Lower Case Profile

Paket İçi Adet  
Quantity Per Package

2

**220** 0,867 kg/m

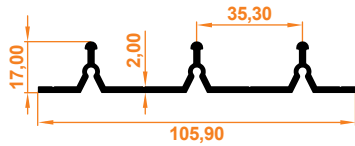

**Üçlü Eşiksiz Alt Kasa Profil**  
Triple Bottom Case Profile without Threshold

Paket İçi Adet  
Quantity Per Package

4

**229** 1,120 kg/m

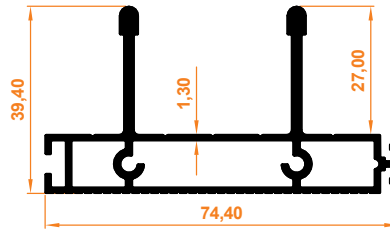

**İkili Üst Kasa Profil**  
Double Upper Case Profile

Paket İçi Adet  
Quantity Per Package

2

**230** 1,552 kg/m

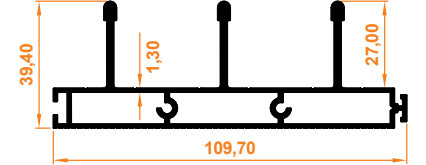

**İkili Üçlü Kasa Profil**  
Triple Upper Case Profile

Paket İçi Adet  
Quantity Per Package

2

**221** 1,156 kg/m

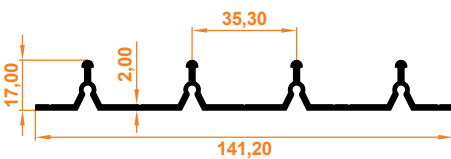

**Dörtlü Eşiksiz Alt Kasa Profil**  
Quadruple Bottom Case Profile without Threshold

Paket İçi Adet  
Quantity Per Package

2

**214** 0,587 kg/m

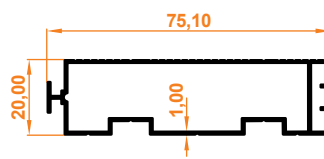

**İkili Yan Kasa Profil**  
Double Side Case Profile

Paket İçi Adet  
Quantity Per Package

4

**223** 0,792 kg/m

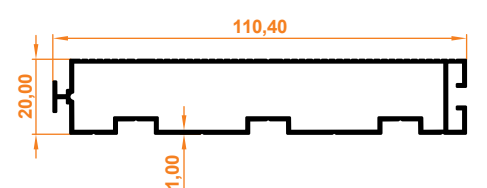

**Üçlü Yan Kasa Profil**  
Triple Side Case Profile

Paket İçi Adet  
Quantity Per Package

2



219

0,219 kg/m

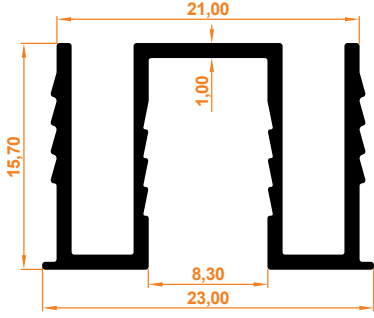

**8 mm Cam Adaptörü**  
8mm Glass Adapter

Paket İçi Adet  
Quantity Per Package

10

226

0,071 kg/m

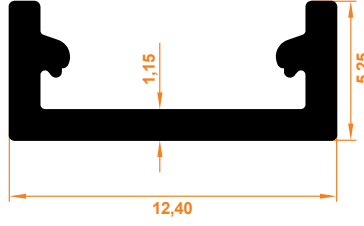

**Kapatma Profil**  
Closing Profile

Paket İçi Adet  
Quantity Per Package

20

227

0,751 kg/m

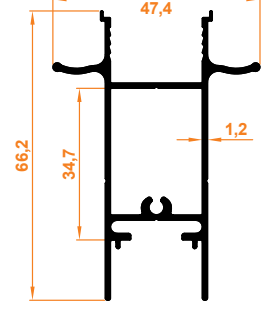

**İspanyolet Çekme Kol Profili**  
Espagnolette Pull Handle Profile

Paket İçi Adet  
Quantity Per Package

3

228

0,156 kg/m

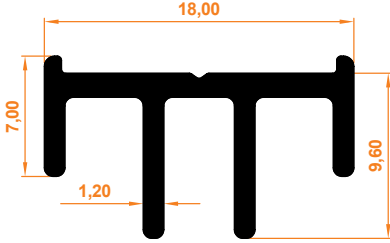

**İspanyolet Karşılık Profili**  
Espagnolette Provision Profile

Paket İçi Adet  
Quantity Per Package

10

## Sürme Sistem Çalışma Mekanizması

Sliding System Operating Mechanism

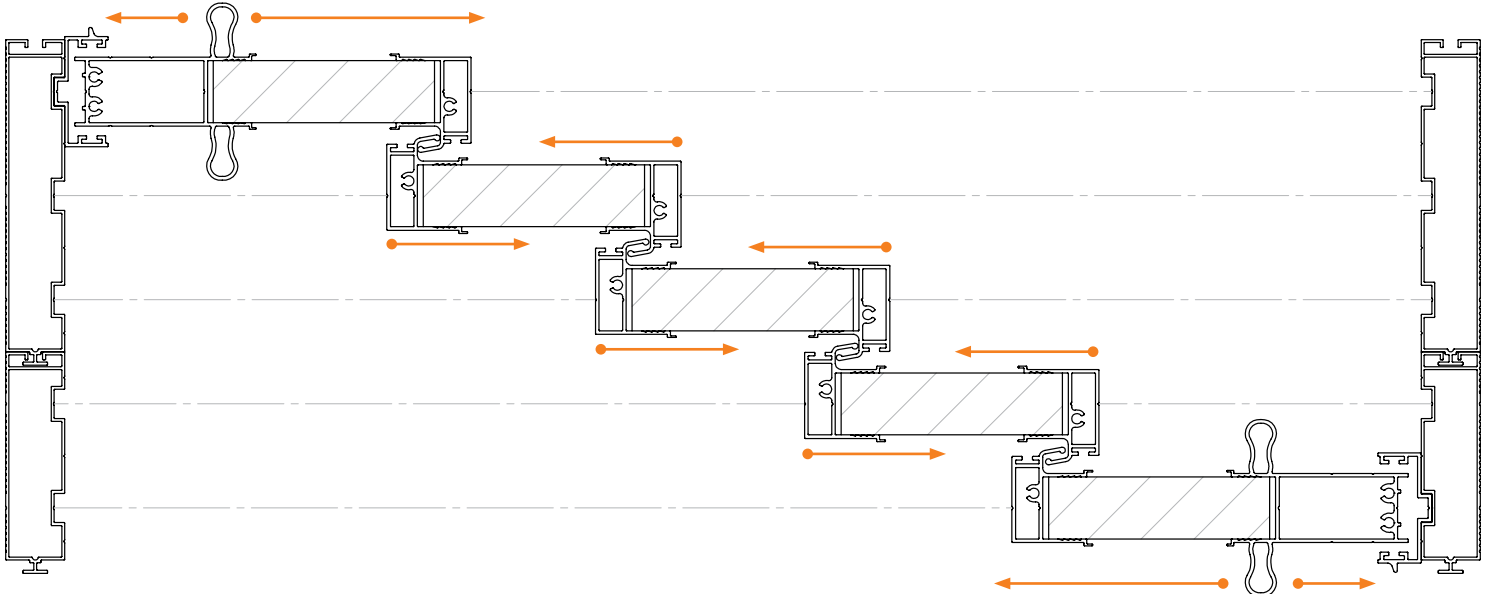

## Sürme Sistem Çalışma Mekanizması

Sliding System Operating Mechanism

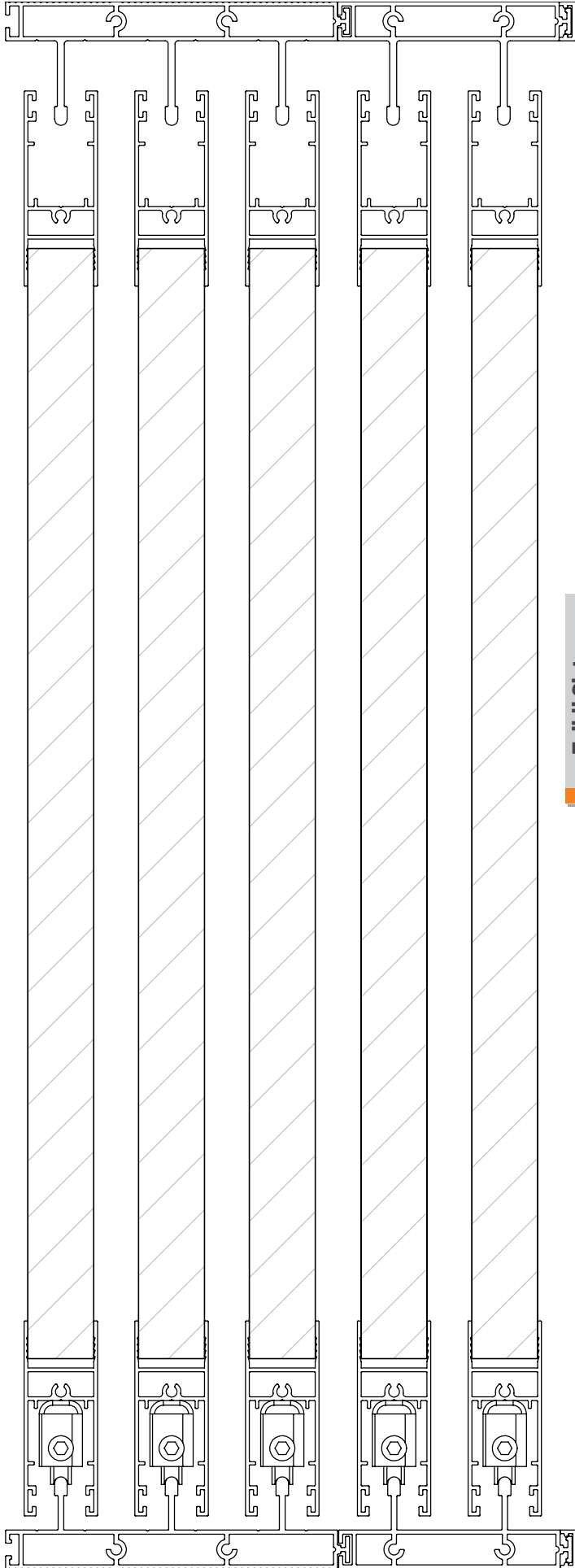

**Eşikli Sistem**  
System with Threshold

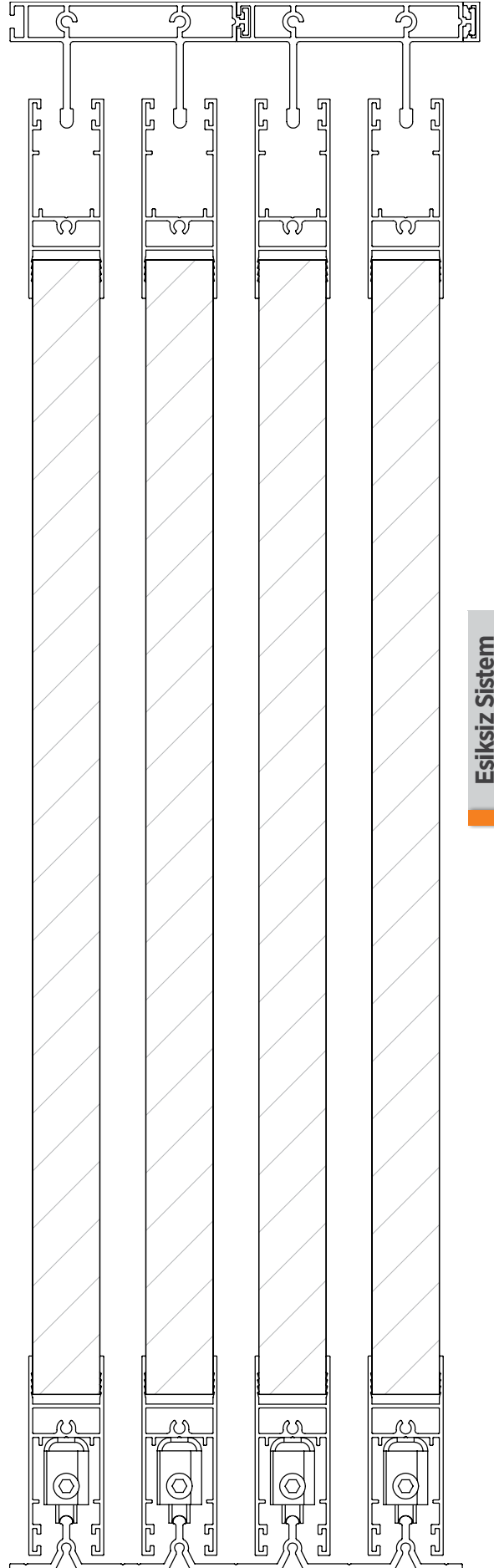

**Eşiksiz Sistem**  
System without Threshold

170

1,343 kg/m

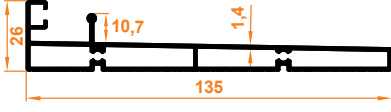

**Alt Kasa Profil**  
Bottom Frame Profile

Paket İçi Adet  
Quantity Per Package

2

171

0,505 kg/m

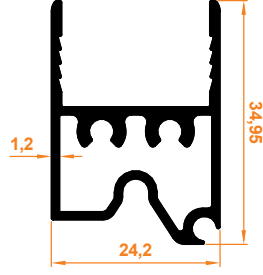

**Bitim Baza Profil**  
End Base Profile

Paket İçi Adet  
Quantity Per Package

6

172

0,377 kg/m

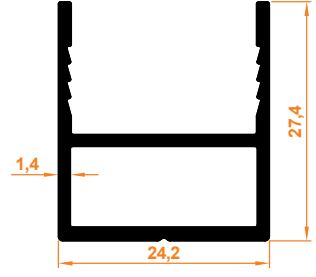

**Dikme Profil**  
Mullion Profile

Paket İçi Adet  
Quantity Per Package

6

173

1,079 kg/m

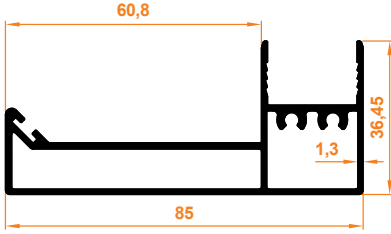

**Geniş Kenet Baza Profil**  
Wide Interlocking Base Profile

Paket İçi Adet  
Quantity Per Package

4

174

0,568 kg/m

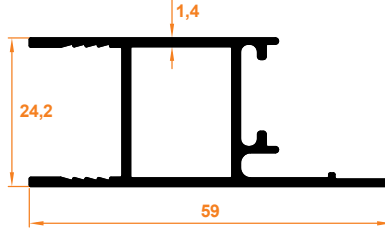

**İspanyolet Dikme Profil**  
Espagnolette Mullion Profile

Paket İçi Adet  
Quantity Per Package

6

175

0,131 kg/m

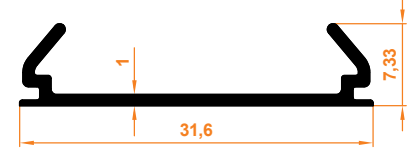

**Kapatma Profil**  
Closing Profile

Paket İçi Adet  
Quantity Per Package

10

176

0,741 kg/m

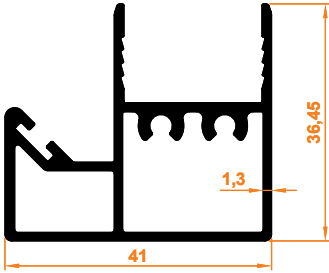

**Kenet Baza Profil**  
Interlocking Base Profile

Paket İçi Adet  
Quantity Per Package

4

177

0,618 kg/m

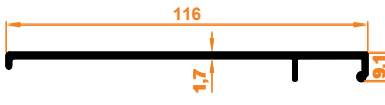

**Küpeste Profil**  
Handrail Profile

Paket İçi Adet  
Quantity Per Package

2

178

0,688 kg/m

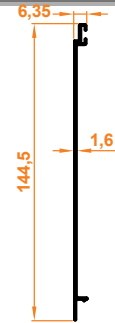

**Üst Kasa Kapak Profil**  
Top Frame Cover Profile

Paket İçi Adet  
Quantity Per Package

2

179

2,644 kg/m

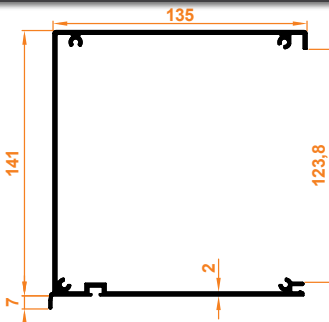

**Üst Kasa Profil**  
Top Frame Profile

Paket İçi Adet  
Quantity Per Package

1

180

0,420 kg/m

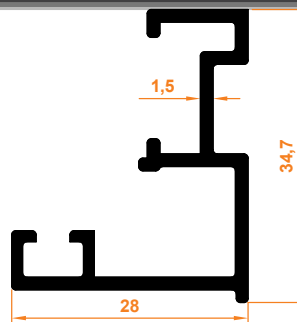

**Yan Karşılık Profil**  
Side Counterpart Profile

Paket İçi Adet  
Quantity Per Package

4

181

1,671 kg/m

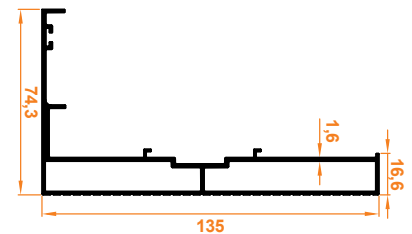

**Yan Kasa Profil**  
Side Frame Profile

Paket İçi Adet  
Quantity Per Package

2

182

0,665 kg/m

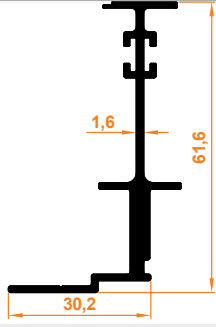

**Yan L Profil**  
Side L Profile

Paket İçi Adet  
Quantity Per Package

4

183

0,927 kg/m

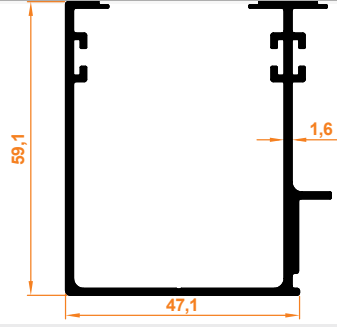

**Yan U Profil**  
Side U Profile

Paket İçi Adet  
Quantity Per Package

4

GYT 28

2,110 kg/m

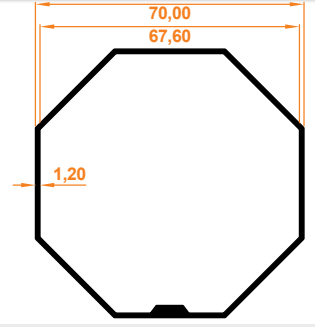

**Sac Tambur Borusu**  
Sheet Metal Drum Tube

Paket İçi Adet  
Quantity Per Package

1

219

0,219 kg/m

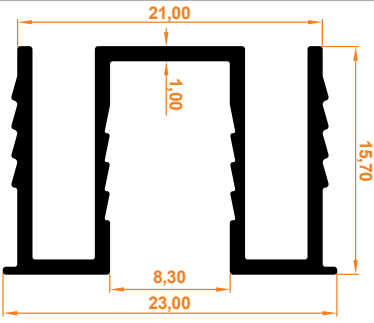

**8 mm Cam Adaptörü**  
8mm Glass Adapter

Paket İçi Adet  
Quantity Per Package

10

## Giyyotin Sistem Çalıřma Mekanizması

Guillotine System Operating Mechanism

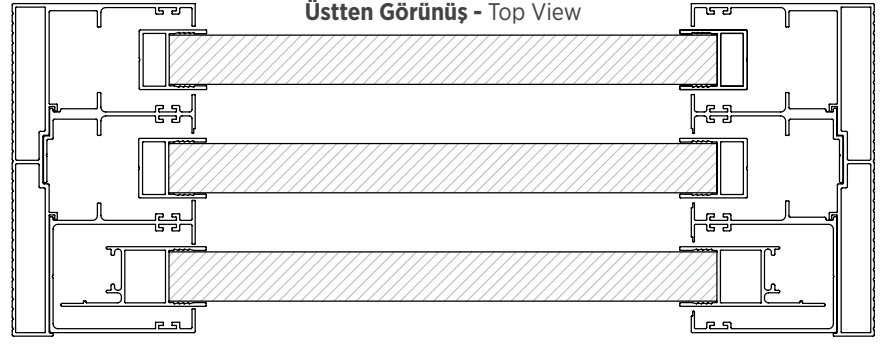

### 1. Kademe - Level 1

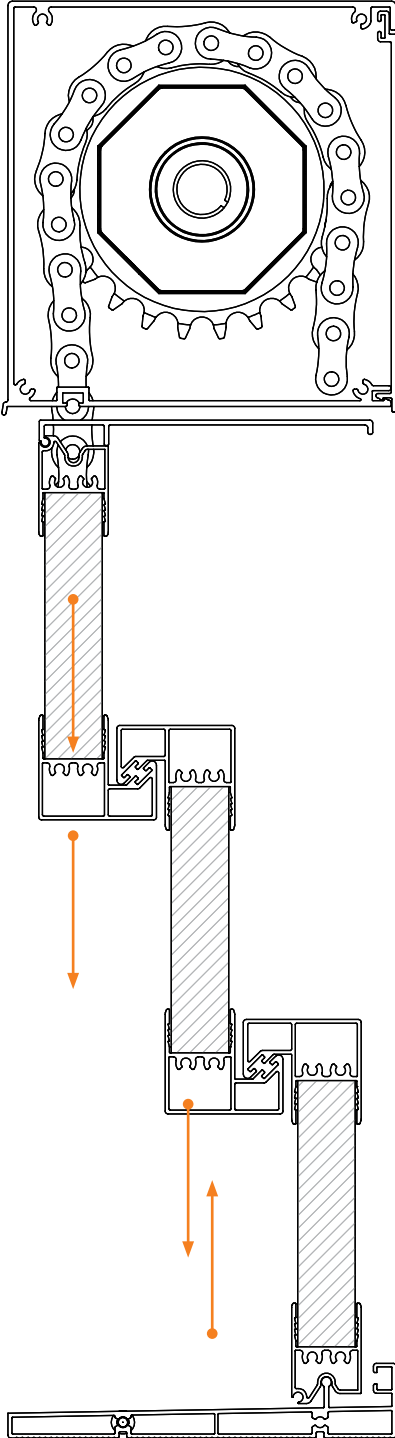

### 2. Kademe - Level 2

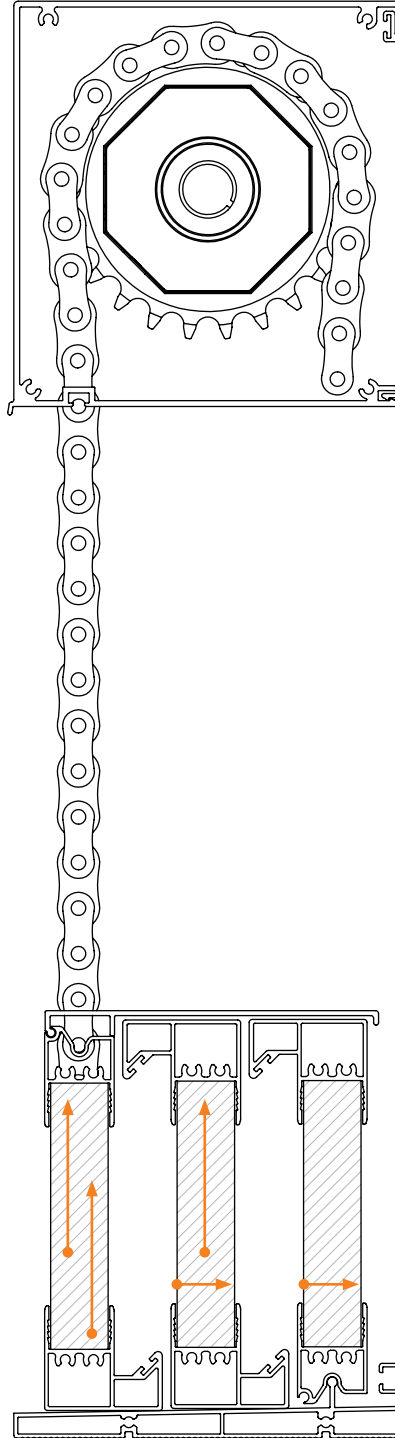

### 3. Kademe - Level 3

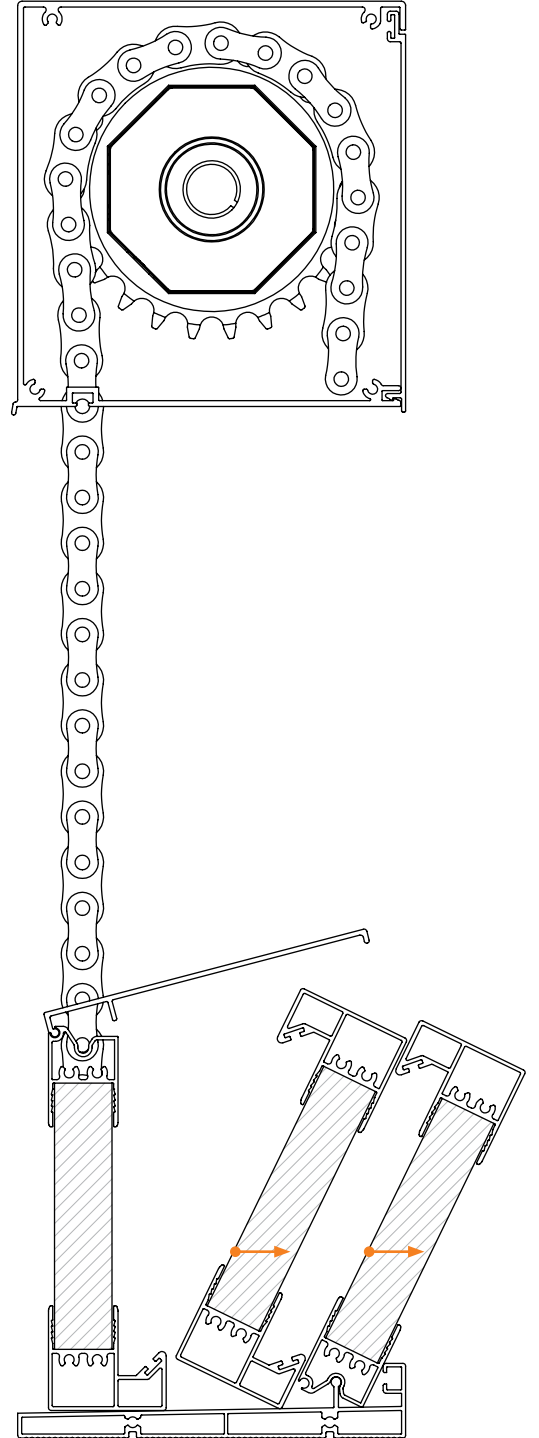

417

0,467 kg/m

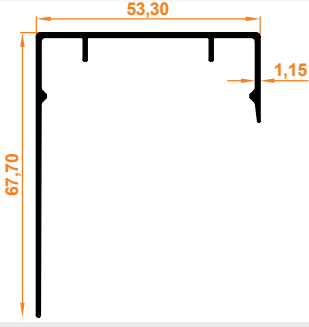

**Sonlandırıcı Cam Çıta Kapak Profili**  
End Cap Glass Strip Cover Profile

Paket İçi Adet  
Quantity Per Package

4

418

0,329 kg/m

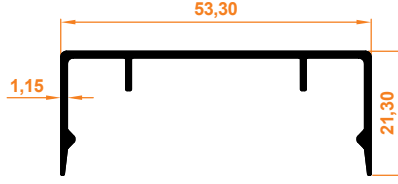

**Cam Çıta Kapak Profili**  
Glass Strip Cover Profile

Paket İçi Adet  
Quantity Per Package

10

419

2,100 kg/m

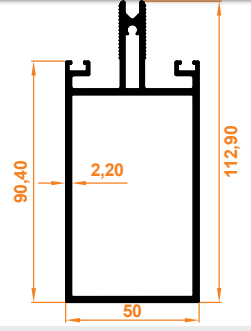

**Orta Kayıt Profili**  
Center Mullion Profile

Paket İçi Adet  
Quantity Per Package

2

420

0,682 kg/m

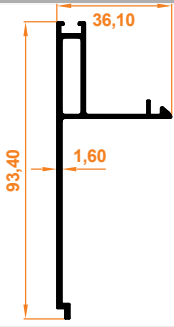

**Kasa Kapatma Profili**  
Frame Closure Profile

Paket İçi Adet  
Quantity Per Package

2

421

3,184 kg/m

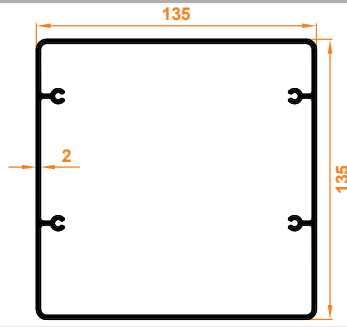

**Ayak Profili**  
Leg Profile

Paket İçi Adet  
Quantity Per Package

1

422

4,318 kg/m

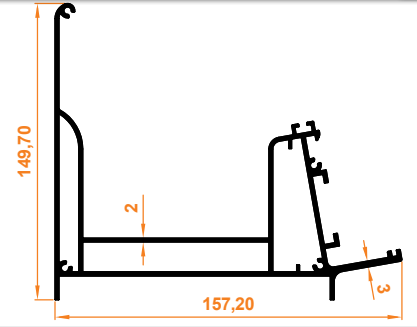

**Oluk Profili**  
Groove Profile

Paket İçi Adet  
Quantity Per Package

1

423

3,142 kg/m

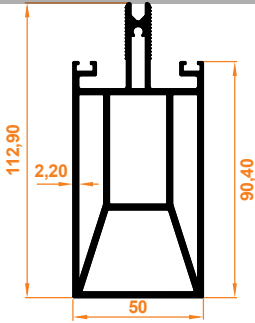

**Destekli Orta Kayıt Profili**  
Reinforced Center Mullion Profile

Paket İçi Adet  
Quantity Per Package

2

424

2,835 kg/m

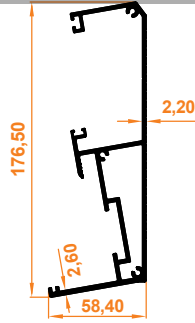

**Duvar Kasa Profili**  
Wall Frame Profile

Paket İçi Adet  
Quantity Per Package

1

426

3,434 kg/m

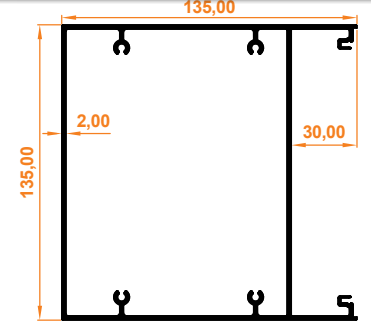

**Gizli Ayak Profili**  
Hidden Leg Profile

Paket İçi Adet  
Quantity Per Package

1

427

2,271 kg/m

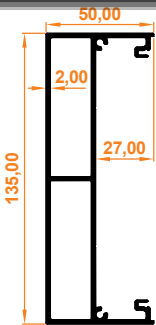

**Destek Kutu Profili**  
Reinforcing Box Profile

Paket İçi Adet  
Quantity Per Package

2

428

0,501 kg/m

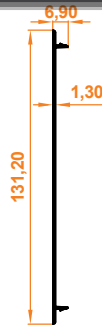

**Gizli Ayak ve Destek Kutu Kapatma Profili**  
Hidden Leg Case Cover Support Profile

Paket İçi Adet  
Quantity Per Package

10

429

0,578 kg/m

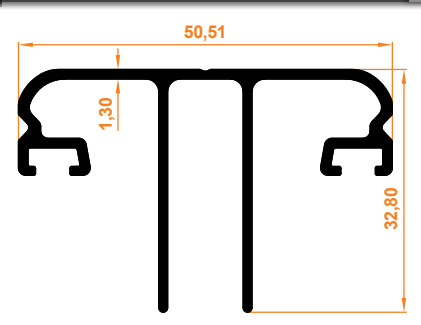

**Cam Çıta Profili**  
Glass Strip Profile

Paket İçi Adet  
Quantity Per Package

2

430

2,252 kg/m

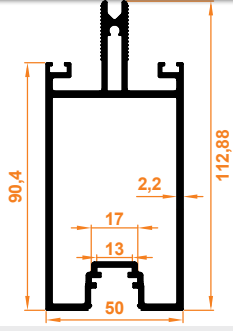

431

0,079 kg/m

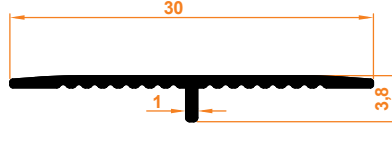

### Ledli Orta Kayıt Profili

Center Mullion Profile with Led

Paket İçi Adet  
Quantity Per Package

2

### T Profili

T Profile

Paket İçi Adet  
Quantity Per Package

10

**7100** 0,921 kg/m

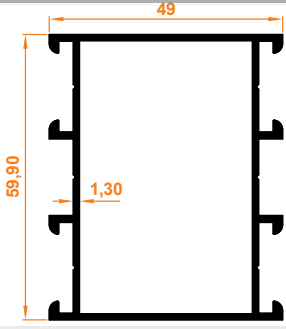

**C60 Kasa Orta Kayıt Profili**  
C60 Case Mid Entry Profile

Paket İçi Adet | 4  
Quantity Per Package

**7101** 0,988 kg/m

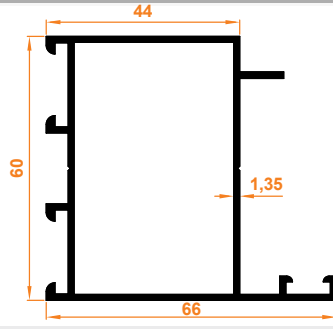

**C60 Kanat Profili**  
C60 Wing Profile

Paket İçi Adet | 4  
Quantity Per Package

**7102** 1,440 kg/m

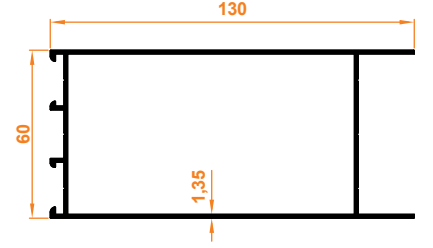

**C60 Etek Profili**  
C60 Skirt Profile

Paket İçi Adet | 2  
Quantity Per Package

**7103** 1,099 kg/m

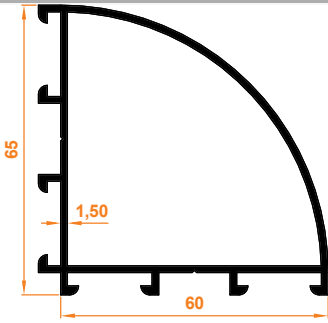

**C60 Oval Köşe Dönüş Profili**  
C60 Oval Corner Profile

Paket İçi Adet | 2  
Quantity Per Package

**7104** 0,436 kg/m

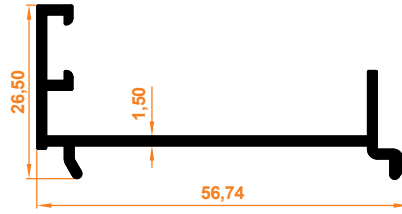

**C60 Kanat Adaptörü Profili**  
C60 Wing Adapter Profile

Paket İçi Adet | 8  
Quantity Per Package

**7105** 1,155 kg/m

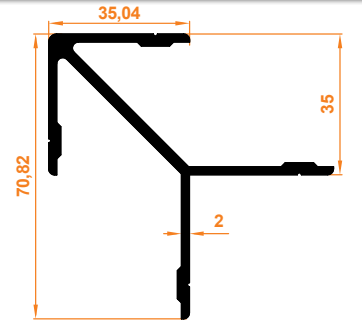

**C60 Köşe Takozu**  
C60 Corner Wedge

Paket İçi Adet | 3  
Quantity Per Package

**7106** 0,467 kg/m

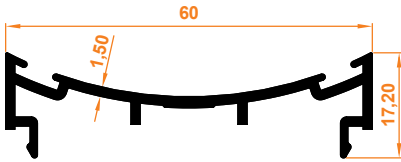

**C60 Çarpma Kapı Adaptörü - Dişi**  
C60 Crash Door Adapter - Female

Paket İçi Adet | 8  
Quantity Per Package

**7107** 0,367 kg/m

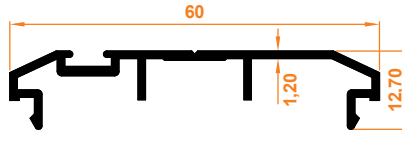

**C60 Çarpma Kapı Adaptörü - Erkek**  
C60 Crash Door Adapter - Male

Paket İçi Adet | 8  
Quantity Per Package

**7108** 0,241 kg/m

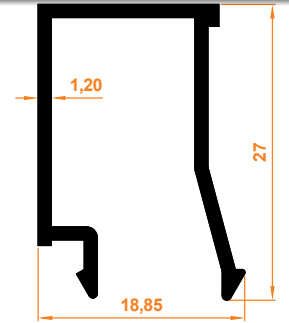

**C60 Isıcam Çıta Profili**  
C60 Insulating Glass Stave Profile

Paket İçi Adet | 24  
Quantity Per Package

**7109** 0,234 kg/m

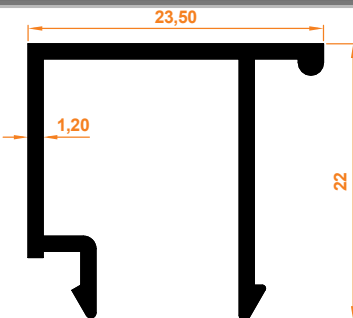

**C60 Tek Cam Çıta Profili**  
C60 Single Glass Stave Profile

Paket İçi Adet | 24  
Quantity Per Package



7000

0,473 kg/m

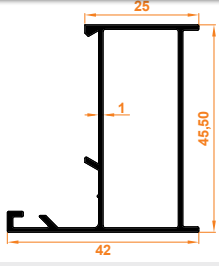

**Aldoks (Dar) Kasa Profili**  
Aldoks (Tight) Frame Profile

Paket İçi Adet  
Quantity Per Package

6

7001

0,565 kg/m

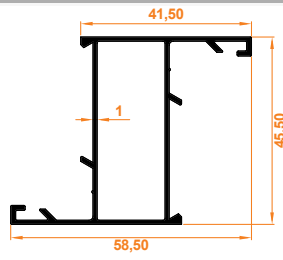

**Aldoks (Dar) Kanat Profili**  
Aldoks (Tight) Wing Profile

Paket İçi Adet  
Quantity Per Package

4

7002

0,565 kg/m

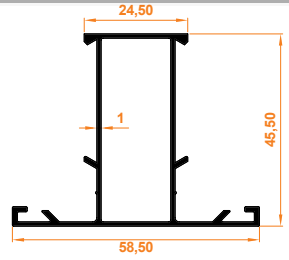

**Aldoks (Dar) Orta Kayıt Profili**  
Aldoks (Tight) Mid Entry Profile

Paket İçi Adet  
Quantity Per Package

4

7003

0,891 kg/m

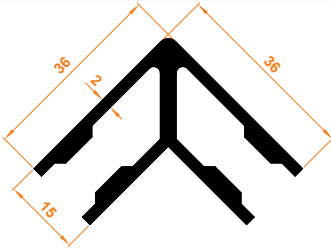

**Aldoks (Dar) Köşe Takozu**  
Aldoks (Tight) Corner Wedge

Paket İçi Adet  
Quantity Per Package

3

7004

0,565 kg/m

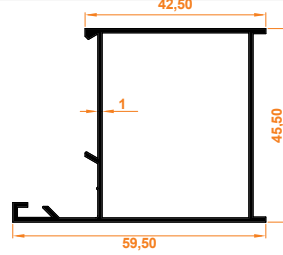

**Aldoks (Orta) Kasa Profili**  
Aldoks (Mid) Frame Profile

Paket İçi Adet  
Quantity Per Package

6

7005

0,659 kg/m

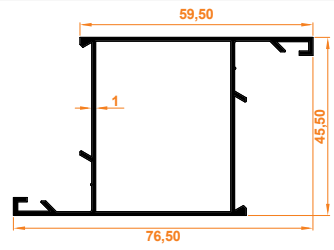

**Aldoks (Orta) Kanat Profili**  
Aldoks (Mid) Wing Profile

Paket İçi Adet  
Quantity Per Package

3

7006

0,659 kg/m

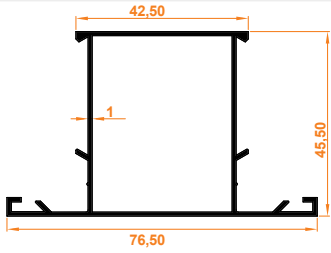

**Aldoks (Orta) Kayıt Profili**  
Aldoks (Mid) Entry Profile

Paket İçi Adet  
Quantity Per Package

3

7007

1,136 kg/m

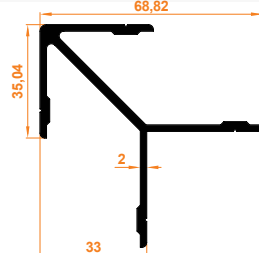

**Aldoks (Orta) Köşe Takozu**  
Aldoks (Mid) Corner Wedge

Paket İçi Adet  
Quantity Per Package

3

7008

0,695 kg/m

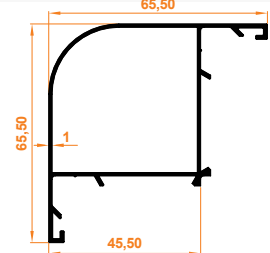

**Aldoks Oval Köşe Dönüş Profili**  
Aldoks Oval Corner Profile

Paket İçi Adet  
Quantity Per Package

2

7009

0,719 kg/m

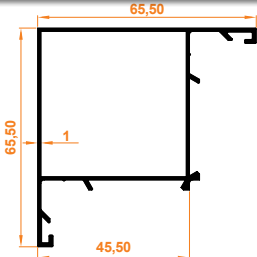

**Aldoks Köşe Dönüş Profili**  
Aldoks Corner Profile

Paket İçi Adet  
Quantity Per Package

2

7010

1,028 kg/m

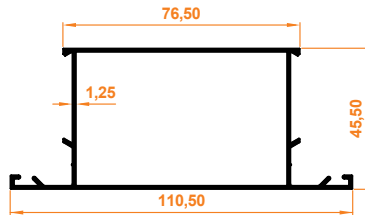

**Aldoks (Geniş) Orta Kayıt Profili**  
Aldoks (Wide) Mid Entry Profile

Paket İçi Adet  
Quantity Per Package

2

7011

1,028 kg/m

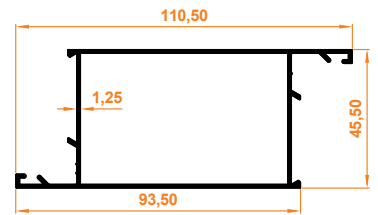

**Aldoks (Geniş) Kanat Profili**  
Aldoks (Wide) Wing Profile

Paket İçi Adet  
Quantity Per Package

2

7012

1,149 kg/m

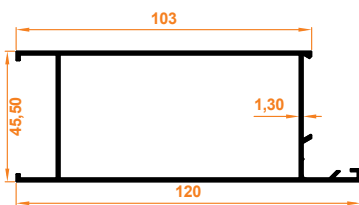

**Aldoks Etek Profili**  
Aldoks Skirt Profile

Paket İçi Adet  
Quantity Per Package

2

7013

0,215 kg/m

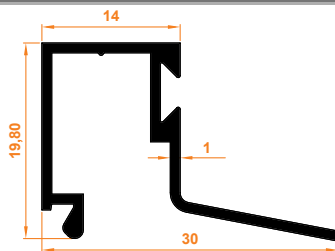

**Aldoks Isıcam Çita**  
Aldoks Double Glazing Stave

Paket İçi Adet  
Quantity Per Package

10

7014

0,213 kg/m

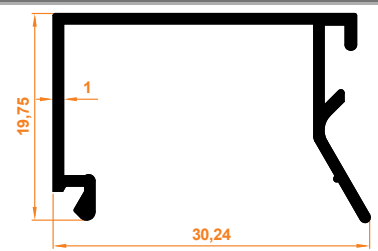

**Aldoks Tek Cam Çita**  
Aldoks Single Glass Stave

Paket İçi Adet  
Quantity Per Package

16

900

0,685 kg/m

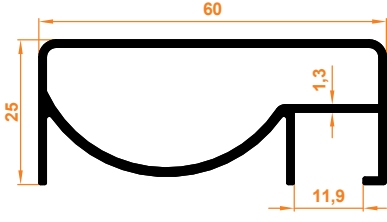

**60x25 mm Üst Kúpeşte Yandan Kanallı**  
60x25 mm Upper Handrail with Side Channel

Paket İçi Adet  
Quantity Per Package

4

901

0,230 kg/m

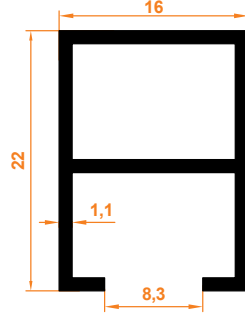

**Cam Tutucu**  
Glass Holder

Paket İçi Adet  
Quantity Per Package

10

902

0,848 kg/m

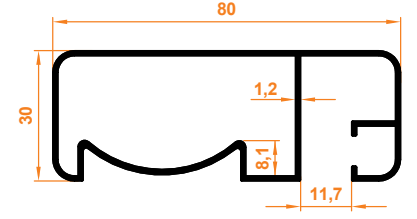

**80x30 Yandan Kanallı**  
80x30 Side Channel

Paket İçi Adet  
Quantity Per Package

4

903

0,785 kg/m

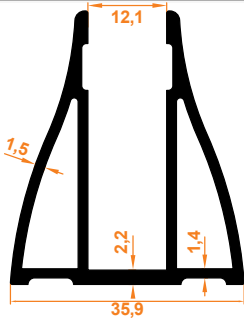

**Cam Alt Baza**  
Glass Bottom Base

Paket İçi Adet  
Quantity Per Package

3

904

0,159 kg/m

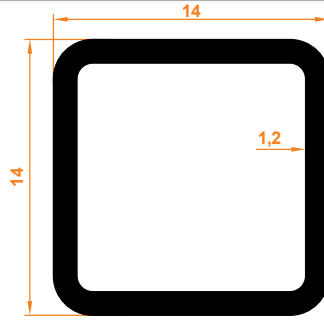

**14x14 Emniyet Şeridi**  
14x14 Safety Strip

Paket İçi Adet  
Quantity Per Package

20

905

0,060 kg/m

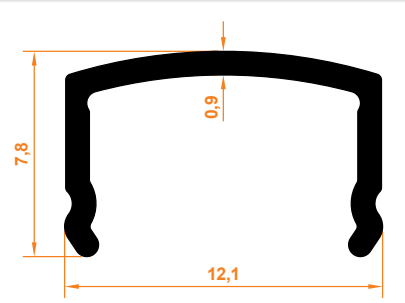

**Boru Çıtası**  
Pipe Lath

Paket İçi Adet  
Quantity Per Package

20

906

0,650 kg/m

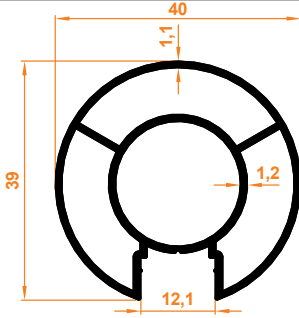

**40x1,1 mm Tek Kanallı Çiftli Dikme**  
40x1,1 mm Single Channel Double Column

Paket İçi Adet  
Quantity Per Package

5

907

0,532 kg/m

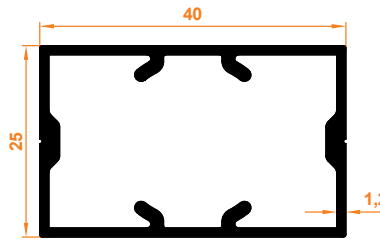

**40x25 Dikme**  
40x25 Column

Paket İçi Adet  
Quantity Per Package

10

908

0,922 kg/m

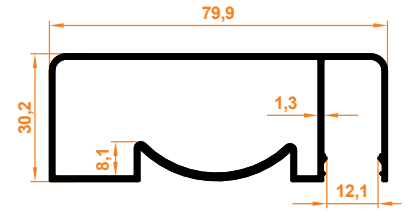

**80x30 Yandan Kanallı**  
80x30 Side Channel

Paket İçi Adet  
Quantity Per Package

4

909

0,717 kg/m

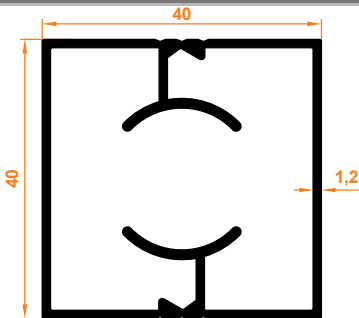

**40x40 Kanalsız Dikme**  
40x40 Non Channel Column

Paket İçi Adet  
Quantity Per Package

3

910

0,631 kg/m

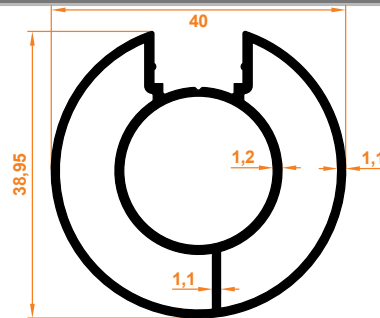

**40x1,1 mm Tek Kanallı Tekli Dikme**  
40x1,1 mm Single Channel Single Column

Paket İçi Adet  
Quantity Per Package

5

911

0,840 kg/m

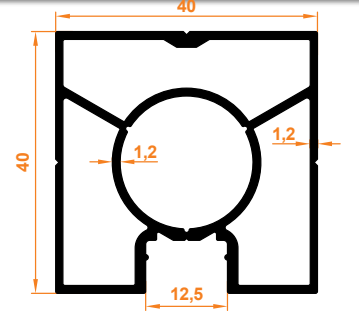

**40x40 Tek Kanallı Dikme**  
40x40 Single Channel Column

Paket İçi Adet  
Quantity Per Package

3

912

0,641 kg/m

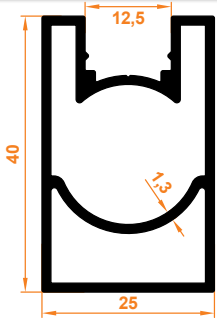

**40x25 Tek Kanallı**  
40x25 Single Slot

Paket İçi Adet  
Quantity Per Package

10

913

0,064 kg/m

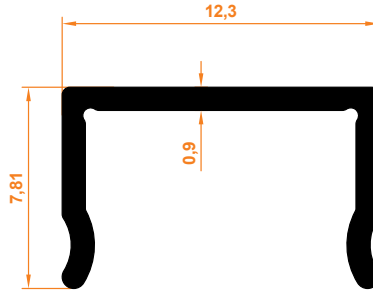

**Kare Çıta**  
Square Slot

Paket İçi Adet  
Quantity Per Package

20

914

0,082 kg/m

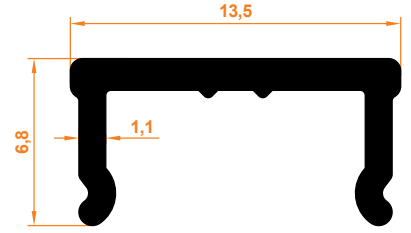

**80x30 Yandan Kanallı Çıtası**  
80x30 Side Slot Rail

Paket İçi Adet  
Quantity Per Package

20

915

0,778 kg/m

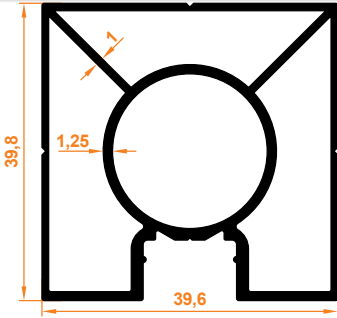

**40x40 Tek Kanallı Dikme**  
40x40 Single Slot Column

Paket İçi Adet  
Quantity Per Package

3

916

0,627 kg/m

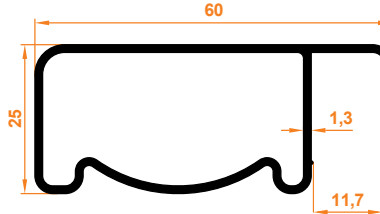

**60x25 Yandan Kanallı**  
60x25 Side Slot

Paket İçi Adet  
Quantity Per Package

4

918

0,256 kg/m

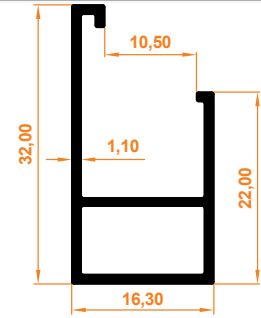

**8-10 mm Cam Altı Profil**  
8-10 mm Glass Bottom

Paket İçi Adet  
Quantity Per Package

10

919

0,807 kg/m

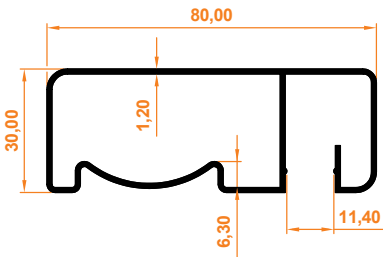

**80x30 Yandan Kanallı**  
80x30 Side Slot

Paket İçi Adet  
Quantity Per Package

4

923

0,326 kg/m

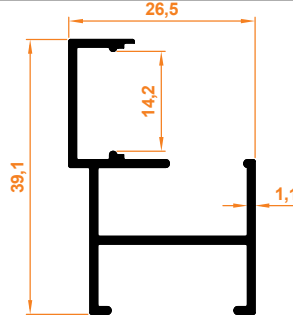

**Cam Tutucu Profil**  
Glass Holder Profile

Paket İçi Adet  
Quantity Per Package

10

924

0,082 kg/m

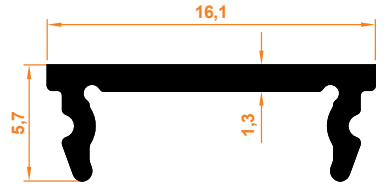

**Takviyesiz Cam Tutucu Çıta Profil**  
Non-Reinforced Glass Holder Lath Profile

Paket İçi Adet  
Quantity Per Package

20

925

0,396 kg/m

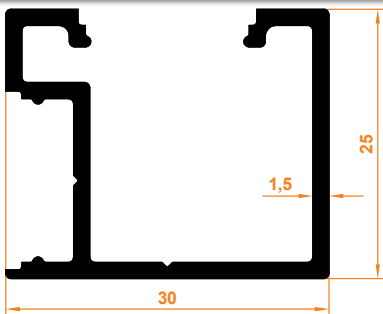

**Takviyesiz Cam Tutucu Profil**  
Non-Reinforced Glass Holder Profile

Paket İçi Adet  
Quantity Per Package

6

926

0,501 kg/m

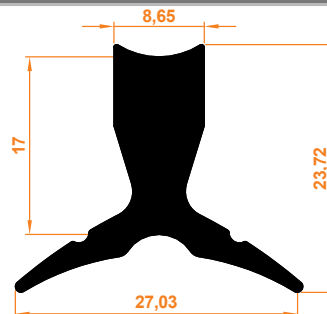

**Y Bağlantı Profil**  
Y-Connector Profile

Paket İçi Adet  
Quantity Per Package

8

927

0,478 kg/m

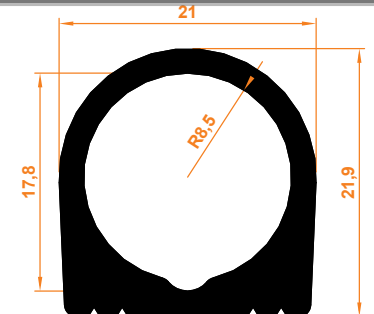

**Boru Tutamak Profil**  
Tube Grip Profile

Paket İçi Adet  
Quantity Per Package

8

700

0,185 kg/m

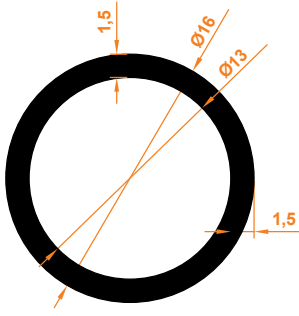

**16x1,5 Boru**  
16x1,5 Pipe

Paket İçi Adet  
Quantity Per Package

12

701

0,538 kg/m

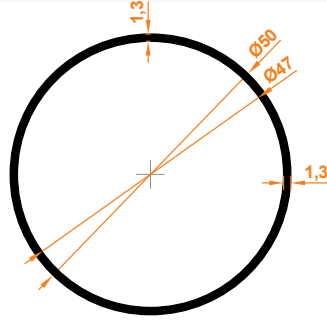

**50x1,3 Boru**  
50x1,3 Pipe

Paket İçi Adet  
Quantity Per Package

3

702

0,509 kg/m

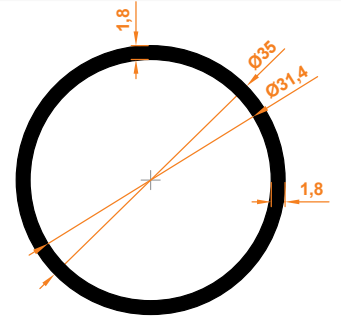

**35x1,8 Boru**  
35x1,8 Pipe

Paket İçi Adet  
Quantity Per Package

5

703

0,182 kg/m

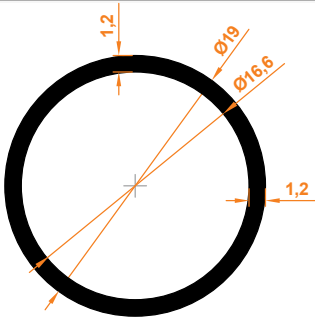

**19x1,2 Boru**  
19x1,2 Pipe

Paket İçi Adet  
Quantity Per Package

12

704

0,162 kg/m

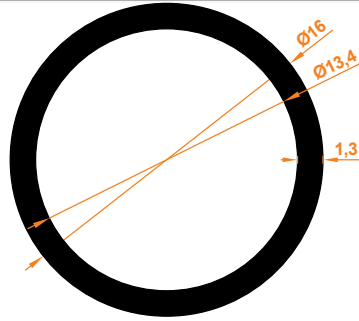

**16x1,3 Boru**  
16x1,3 Pipe

Paket İçi Adet  
Quantity Per Package

12

250

1,288 kg/m

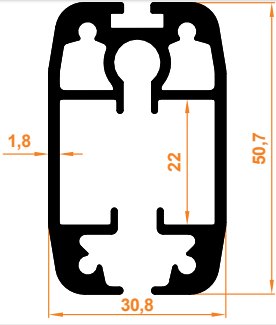

**Kanat Profili**  
Wing Profile

Paket İçi Adet  
Quantity Per Package

2

251

0,572 kg/m

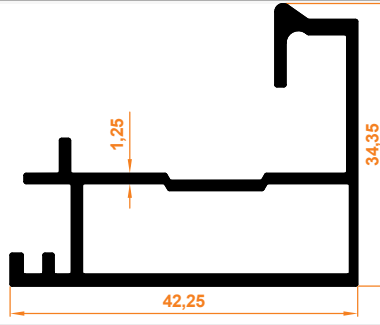

**Yan Kasa Profili**  
Side Case Profile

Paket İçi Adet  
Quantity Per Package

6

252

0,313 kg/m

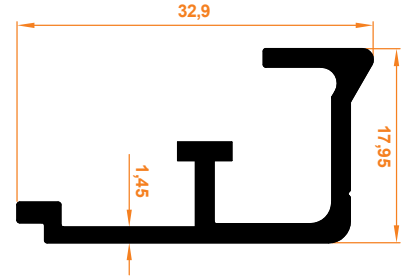

**Yan Kasa Kapak Profili**  
Side Case Cover Profile

Paket İçi Adet  
Quantity Per Package

10

7150

1,776 kg/m

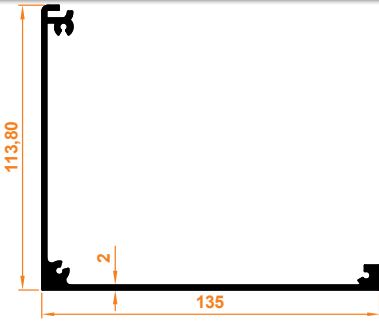

**Üst Kasa Profili**  
Upper Case Profile

Paket İçi Adet  
Quantity Per Package

2

7151

1,475 kg/m

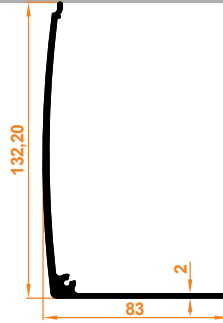

**Üst Kasa Kapak Profili**  
Upper Case Cover Profile

Paket İçi Adet  
Quantity Per Package

2

ZP 13

2,110 kg/m

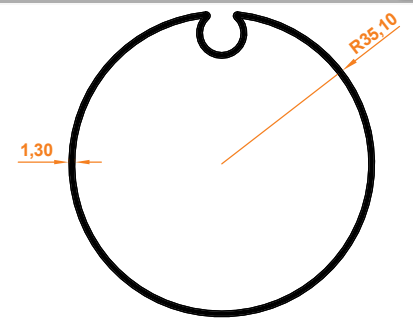

**Sac Tambur Borusu**  
Sheet Drum Tube

Paket İçi Adet  
Quantity Per Package

1

ZP 15

1,300 kg/m



**8x20 Lama Demir**  
8x20 Blade Iron

Paket İçi Adet  
Quantity Per Package

1

362

0,167 kg/m

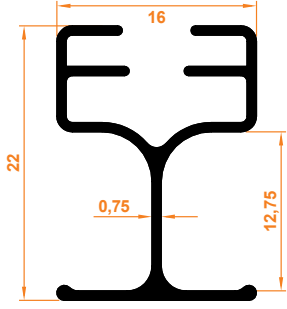

**T Profil**  
T Profile

Paket İçi Adet  
Quantity Per Package

10

357

0,162 kg/m

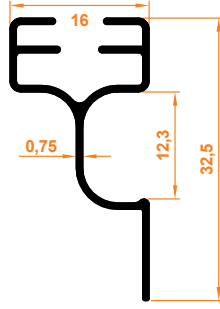

**Etekli T Profil**  
Skirted T Profile

Paket İçi Adet  
Quantity Per Package

10

334

0,265 kg/m

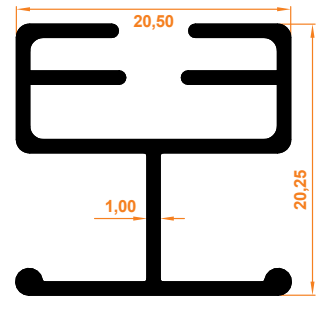

**20'lik T Profil**  
20 T Profile

Paket İçi Adet  
Quantity Per Package

10

332

0,094 kg/m

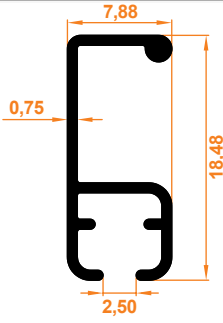

**Small T Profil**  
Small T Profile

Paket İçi Adet  
Quantity Per Package

10

945

0,193 kg/m

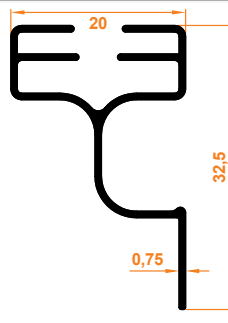

**Etekli 20'lik T Profil**  
Skirted 20 T Profile

Paket İçi Adet  
Quantity Per Package

10

327

0,252 kg/m

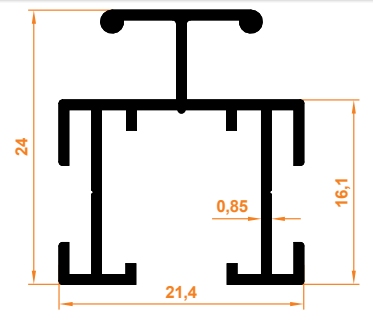

**Çiftli Orta Profil**  
Double Middle Profile

Paket İçi Adet  
Quantity Per Package

10

339

0,102 kg/m

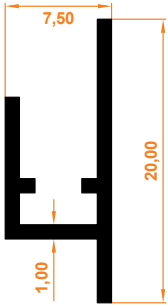

**Yaylı Yapışkan Profil**  
Spring Adhesive Profile

Paket İçi Adet  
Quantity Per Package

10

340

0,076 kg/m

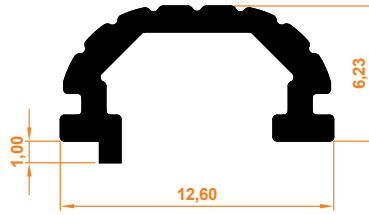

**Yaylı Portray Profil**  
Spring Portray Profile

Paket İçi Adet  
Quantity Per Package

10

330

0,105 kg/m



**Portray Yapışkan Profil**  
Adhesive Profile

Paket İçi Adet  
Quantity Per Package

10

20

0,203 kg/m

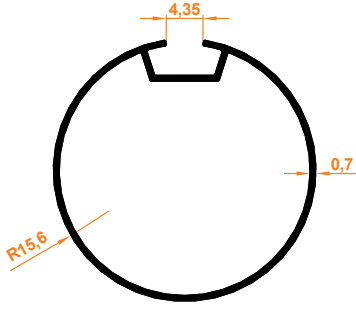

**32'lik Boru**  
Ø32 Roller Tube

Paket İçi Adet  
Quantity Per Package

10

21

0,420 kg/m

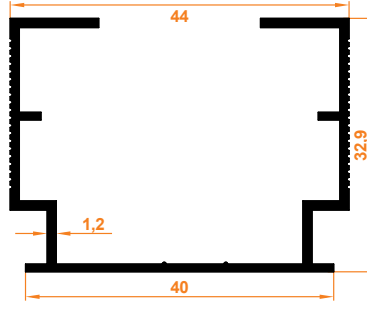

**Dikey Geniş Kasa**  
Vertical Wide Headbox

Paket İçi Adet  
Quantity Per Package

10

23

0,185 kg/m

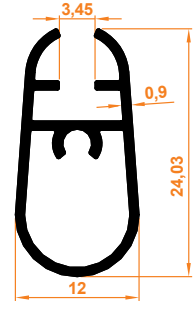

**Minyatür Lama**  
Mini Flat Bar

Paket İçi Adet  
Quantity Per Package

10

24

0,188 kg/m

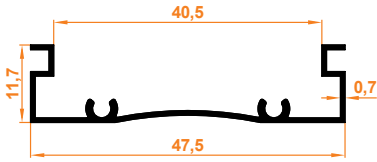

**Stor Perde Kasa Tırnaksız**  
Toothless Headbox for Roller Blinds

Paket İçi Adet  
Quantity Per Package

10

25

0,240 kg/m

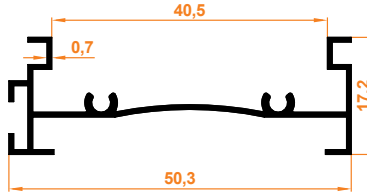

**Zebra Açık Kasa**  
Open Cassette for Zebra Blinds

Paket İçi Adet  
Quantity Per Package

10

26

0,106 kg/m

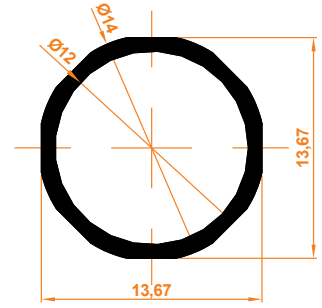

**Zebra Mil**  
Zebra Blind Shaft

Paket İçi Adet  
Quantity Per Package

10

27

0,362 kg/m

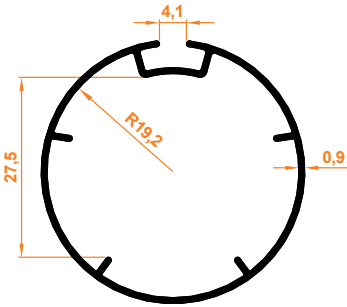

**Zebra Perde Borusu**  
Zebra Blind Tube

Paket İçi Adet  
Quantity Per Package

7

28

0,549 kg/m

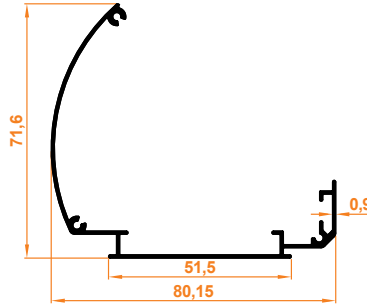

**Zebra Perde Kapalı Kasa**  
Closed Cassette for Zebra Blinds

Paket İçi Adet  
Quantity Per Package

6

29

0,060 kg/m

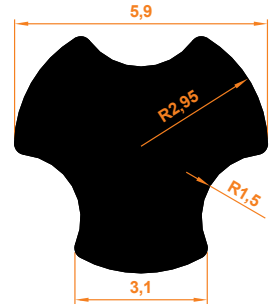

**Zebra Dikey Mil**  
Vertical Shaft for Zebra Blinds

Paket İçi Adet  
Quantity Per Package

25

32

0,094 kg/m

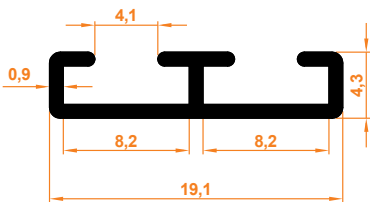

**Zebra Üst Çıta Profil**  
Zebra Upper Rail Profile

Paket İçi Adet  
Quantity Per Package

10

33

0,380 kg/m

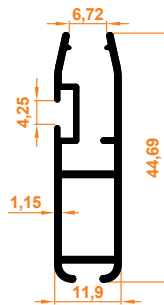

**Zebra Dekoratif Lama Profil**  
Zebra Decorative Slat Profile

Paket İçi Adet  
Quantity Per Package

10

34

0,206 kg/m

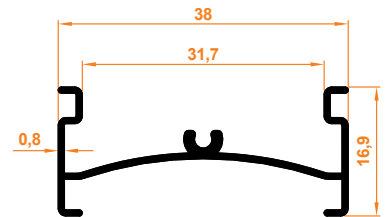

**Dar Kasa Stor Profil**  
Narrow-Case Roller Blind Profile

Paket İçi Adet  
Quantity Per Package

10

35

0,586 kg/m

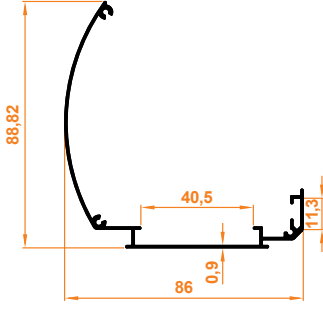

**Kapalı Kasa Geniş Profil**  
Wide Closed-Case Profile

Paket İçi Adet  
Quantity Per Package

6

36

0,923 kg/m

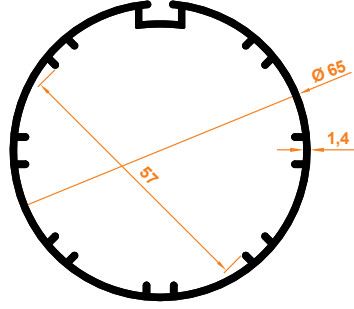

**Zebra Perde 65'lik Motor Boru**  
Zebra Blind Ø65 Motor Tube

Paket İçi Adet  
Quantity Per Package

7

37

0,753 kg/m

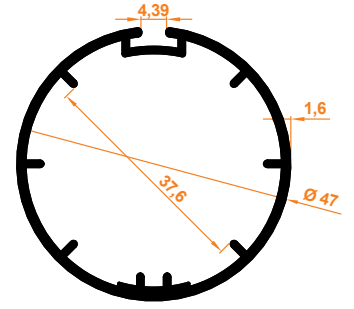

**Zebra Perde 47'lik Motor Boru**  
Zebra Blind Ø47 Motor Tube

Paket İçi Adet  
Quantity Per Package

10

**AHŞAP JALUZİ PROFİL GRUBU**  
Wooden Venetian Blind Profile Group

30

0,605 kg/m

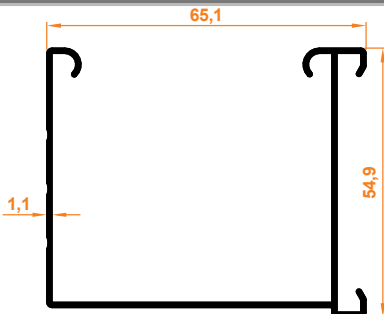

**Ahşap Jaluzi Perde Kasa Profil**  
Venetian Blind Headrail Profile

Paket İçi Adet  
Quantity Per Package

6

31

0,253 kg/m

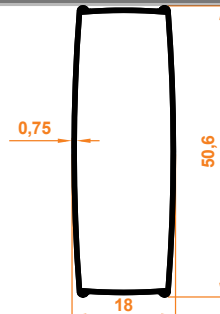

**Ahşap Jaluzi Perde Etek Profil**  
Venetian Blind Bottomrail Profile

Paket İçi Adet  
Quantity Per Package

6



200

0,136 kg/m

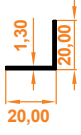

**20x20 Köşebent**  
20x20 Angle Bracket

Paket İçi Adet | 15  
Quantity Per Package

201

0,207 kg/m

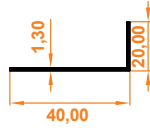

**20x40 Köşebent**  
20x40 Angle Bracket

Paket İçi Adet | 15  
Quantity Per Package

202

0,277 kg/m

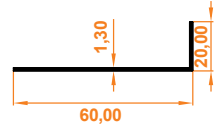

**20x60 Köşebent**  
20x60 Angle Bracket

Paket İçi Adet | 10  
Quantity Per Package

204

0,347 kg/m

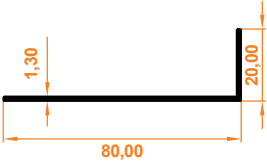

**20x80 Köşebent**  
20x80 Angle Bracket

Paket İçi Adet | 10  
Quantity Per Package

203

0,418 kg/m

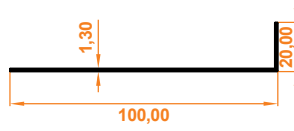

**20x100 Köşebent**  
20x100 Angle Bracket

Paket İçi Adet | 5  
Quantity Per Package

205

0,488 kg/m

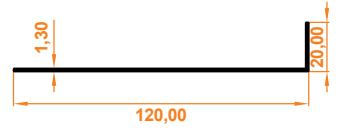

**20x120 Köşebent**  
20x120 Angle Bracket

Paket İçi Adet | 5  
Quantity Per Package

206

0,592 kg/m



**20x150 Köşebent**  
20x150 Angle Bracket

Paket İçi Adet | 5  
Quantity Per Package

**404**

**0,384 kg/m**

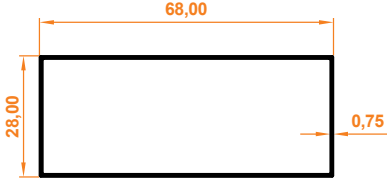

**28x68 Kutu Profil**  
28x68 Box Profile

Paket İçi Adet | 4  
Quantity Per Package

**1044**

**0,960 kg/m**

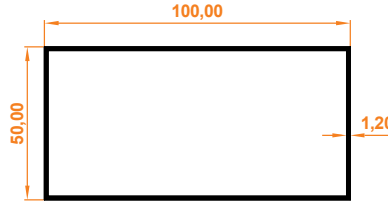

**50x100 Kutu Profil**  
50x100 Box Profile

Paket İçi Adet | 5  
Quantity Per Package

**1102**

**0,531 kg/m**

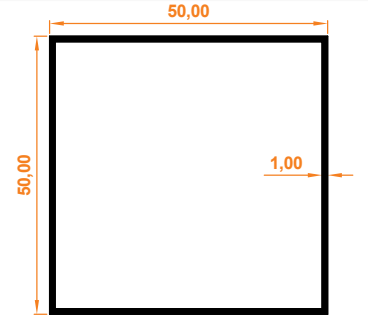

**50x50 Kutu Profil**  
50x50 Box Profile

Paket İçi Adet | 3  
Quantity Per Package

**1400**

**0,426 kg/m**

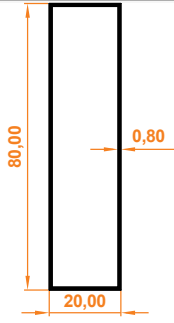

**20x80 Kutu Profil**  
20x80 Box Profile

Paket İçi Adet | 5  
Quantity Per Package

**1402**

**0,917 kg/m**

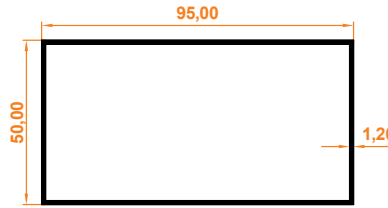

**95x50 Kutu Profil**  
95x50 Box Profile

Paket İçi Adet | 3  
Quantity Per Package

**1403**

**0,505 kg/m**

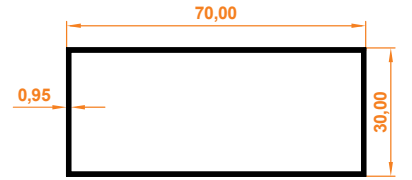

**30x70 Kutu Profil**  
30x70 Box Profile

Paket İçi Adet | 5  
Quantity Per Package

**920**

**0,422 kg/m**

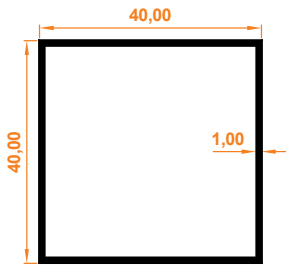

**40x40 Kutu Profil**  
40x40 Box Profile

Paket İçi Adet | 6  
Quantity Per Package

**921**

**0,477 kg/m**

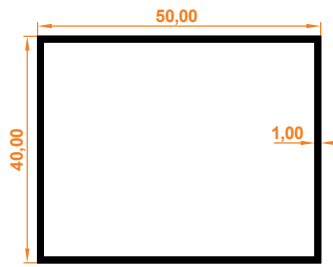

**40x50 Kutu Profil**  
40x50 Box Profile

Paket İçi Adet | 8  
Quantity Per Package

**922**

**0,531 kg/m**

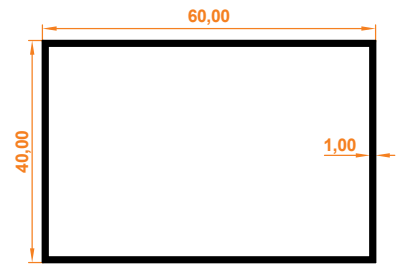

**40x60 Kutu Profil**  
40x60 Box Profile

Paket İçi Adet | 8  
Quantity Per Package

**7180**

**0,576 kg/m**

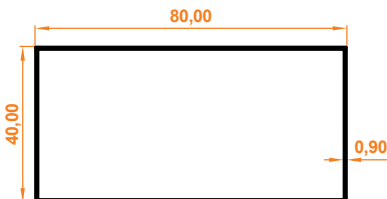

**40x80 Kutu Profil**  
40x80 Box Profile

Paket İçi Adet | 4  
Quantity Per Package

# PANJUR PROFİL GRUBU

Shutter Profile Group

7

0,305 kg/m

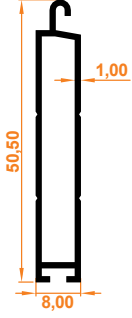

**39x55 Alt Parça**  
39x55 Lower Part

Paket İçi Adet  
Quantity Per Package

6

8

0,502 kg/m

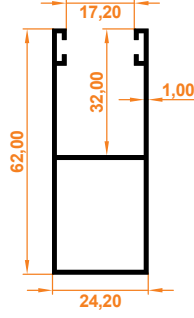

**55'lik Yan Dikme**  
55 Side Column

Paket İçi Adet  
Quantity Per Package

5

9

0,439 kg/m

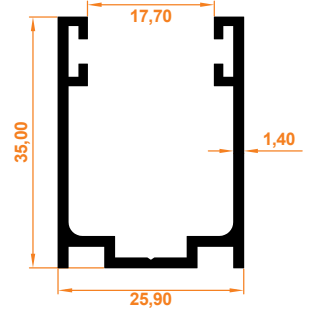

**55'lik Kutusuz Dikme**  
55 Side Column Boxless

Paket İçi Adet  
Quantity Per Package

6

1130

0,372 kg/m

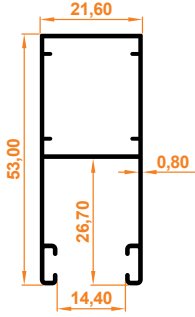

**39'luk Yan Dikme**  
39 Side Column

Paket İçi Adet  
Quantity Per Package

5

353

0,259 kg/m

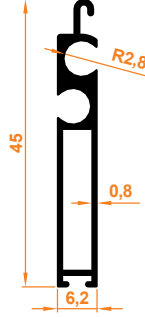

**39x55 Alt Parça Kilitli Profil**  
39x55 Bottom Locking Profile

Paket İçi Adet  
Quantity Per Package

6

1130

0,372 kg/m

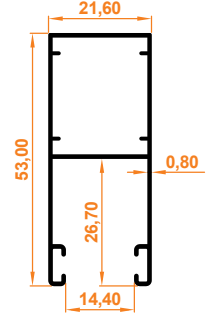

**39'luk Yan Dikme**  
39 Side Column

Paket İçi Adet  
Quantity Per Package

5

# ÖZEL ÜRETİM PROFİL GRUBU

Special Production Profile Group

510

1,174 kg/m

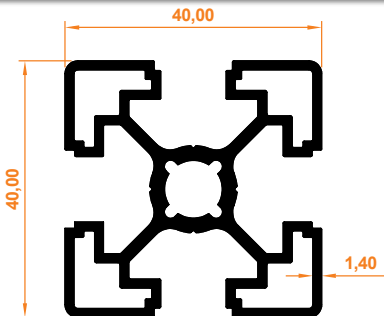

**40x40 Sigma Profil**  
40x40 Sigma Profile

Paket İçi Adet  
Quantity Per Package

3

1003

0,053 kg/m

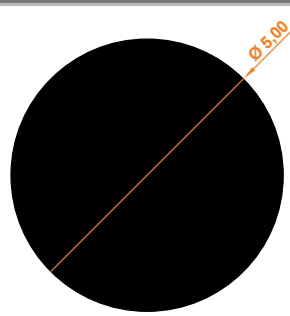

**Q5 Dolu Mil**  
Q5 Solid Bar

Paket İçi Adet  
Quantity Per Package

25



 demarco  panjurmen  prosin  process plise

 Process Alüminyum Plastik San. Tic. Ltd. Şti.

#### MERKEZ

Aşağıpınarbaşı OSB Mah. 524 Nolu Sk. No: 3/1  
42250, Selçuklu-Konya/TÜRKİYE

T : +90 332 248 00 92

F : +90 332 248 00 93

M : info@process.com.tr

#### MARMARA BÖLGE MÜDÜRLÜĞÜ

Cihangir Mh. Talatpaşa Cad. No:67  
Avcılar/İSTANBUL - TÜRKİYE

T : +90 212 407 17 42

F : +90 212 407 15 42

M : marmara@process.com.tr



|| [www.demarco.com.tr](http://www.demarco.com.tr) || [www.processplise.com.tr](http://www.processplise.com.tr) || [www.panjurmen.com.tr](http://www.panjurmen.com.tr) || [www.prosin.com.tr](http://www.prosin.com.tr)

[www.process.com.tr](http://www.process.com.tr)